

The Design, Construction, and Use of an

Indirect, Through-Pass, Solar Food Dryer

Dennis Scanlin

©1997 Dennis Scanlin

Drying is our oldest method of food preservation. For several thousand years people have been preserving dates, figs, apricots, grapes, herbs, potatoes, corn, milk, meat, and fish by drying. Until canning was developed at the end of the 18th century, drying was virtually the only method of food preservation. It is still the most widely used method. Drying is an excellent way to preserve food and solar food dryers are an appropriate food preservation technology for a sustainable world.



Food scientists have found that by reducing the moisture content of food to between 10 and 20%, bacteria, yeast, mold and enzymes are all prevented from spoiling it. The flavor and most of the nutritional value is preserved and concentrated. Vegetables, fruits, meat, fish and herbs can all be dried and can be preserved for several years in many cases. They only have 1/3 to 1/6 the bulk of raw, canned or frozen foods and only weigh about 1/6 that of the fresh food product. They don't require any special storage equipment and are easy to transport.

The solar dryer which will be described in this article is easy to build with locally available tools and materials (for the most part) for about \$150 and operates simply by natural convection. It can dry a full load of fruit or vegetables (7–10 lbs) thinly sliced in two sunny to partly sunny days in our humid Appalachian climate or a smaller load in one good sunny day. Obviously the amount of sunshine and humidity will affect performance, with better performance on clear, sunny and less humid days. However, some drying does take

place on partly cloudy days and food can be dried in humid climates. The dryer was developed at Appalachian State University in the Department of Technology's Appropriate Technology Program. Over the last 12 years we have designed, built, and tested quite a few dryers and this one has been our best. It was originally developed for the Honduras Solar Education Project, which Appalachian State implemented several years ago. The prototype for that project was constructed by Chuck Smith, a graduate student in the Technology Department. Amy Martin, another Appalachian student, constructed the modified and improved version depicted in this article. Solar dryers are a good way to introduce students to solar thermal energy technology. They have the same basic components as do all low temperature solar thermal energy conversion systems. They can be easily constructed at the school for small sums of money and in a fairly short amount of time, and they work very well. While conceptually a simple technology, solar drying is more complex than one might imagine and much still needs to be learned about it. Perfecting this technology



Above: Yum...the apples are almost ready.

has been one of our goals and while we are not there yet, over the years we have come up with some designs that work pretty well. This article will describe guidelines for designing, constructing and using a solar food dryer.

Factors affecting food drying

There are three major factors affecting food drying: temperature, humidity and air flow. They are interactive. Increasing the vent area by opening vent covers will decrease the temperature and increase the air flow, without having a great effect on the relative humidity of the entering air. In general more air flow is desired in the early stages of drying to remove free water or water around the cells and on the surface. Reducing the vent area by partially closing the vent covers will increase the temperature and decrease the relative humidity of the entering air and the air flow. This would be the preferred set up during the later stages of drying when the bound water needs to be driven out of the cells and to the surface.

Temperature

There is quite a diversity of opinion on the ideal drying temperatures. Food begins cooking at 180°F so one would want to stay under this temperature. All opinions surveyed fall between 95° and 180°F, with 110°–140°F being most common. Recommended temperatures vary depending on the food being dried. Our experience thus far and the research of quite a few others leads to the conclusion that in general higher temperatures (up to 180°F) increase the speed of drying. One study found that it took

approximately 5 times as long to dry food at 104°F as it did at 176°F. Higher temperatures (135°–180°F) also destroy bacteria, enzymes (158°F), fungi, eggs and larvae. Food will be pasteurized if it is exposed to 135°F for 1 hour or 176°F for 10–15 min. Most bacteria will be destroyed at 165°F and all will be prevented from growing between 140°–165°. Between 60° and 140°F bacteria can grow and many will survive, although bacteria, yeasts and molds all require 13% or more moisture content for growth which they won't have in most dried foods.

Some recommended drying temperatures are:

Fruits and Vegetables: (except beans and rice): 100°–130°F (Wolf, 1981); 113°–140° (NTIS, 1982); temperatures over 65°C (149°F) can result in sugar caramelization of many fruit products

Meat: 140°–150° F (Wolf, 1981)

Fish: no higher than 131°F (NTIS, 1982); 140°–150° (Wolf, 1981)

Herbs: 95°–105°F (Wolf, 1981)

Livestock Feed: 75°C (167°F) maximum temperature. (NTIS, 1982)

Rice, Grains, Seeds, Brewery Grains: 45°C (113°F) maximum temperature. (NTIS, 1982)

Temperatures Obtainable in our Appalachian Dryer

Our Appalachian dryer, with a reflector added, has reached temperatures over 200°F on a sunny 75°F day with all the vents closed. Preliminary experiences with a 4' long reflector have demonstrated a 20°F rise in the

Below: Adjusting the vents and testing (tasting?) the progress.



Chart 1

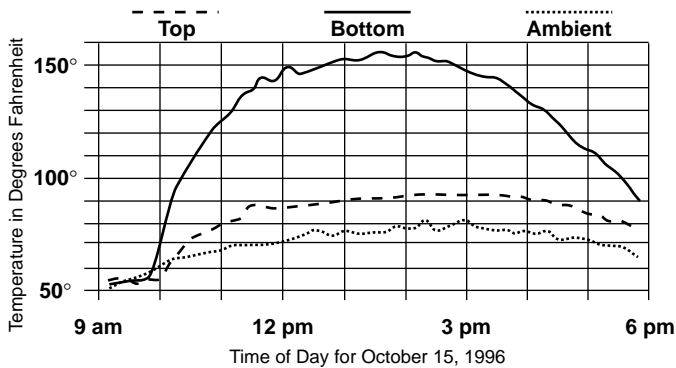

dryer temperature and a decrease in drying time. By fully opening the vents the temperature can be brought down to within 10° or 20° higher than the ambient temperature. The dryer can operate for most of the day between 120° and 155°F by opening the exhaust vents 1–2" (10–20 sq. in.). These are the temperatures at the bottom of the food drying area when the dryer has just been filled with food and a reflector is being used. The temperature drops significantly as it passes through the moist food. Chart 1 shows: the temperatures below the bottom tray of food, the temperatures above the top tray of food, and the ambient temperatures, right after a full load of 25 sliced apples (about 8 lbs) had been placed in the dryer. The dryer on this day had a reflector on it. It was a clear sunny day with relative humidities between 62 and 93%. By the end of the day, apples on bottom 5 trays were dry, some apples on top 5 trays were not. The temperatures were recorded with a Pace Scientific Pocket Logger, model XR220, 1401 McLaughlin Drive, P.O. Box 10069, Charlotte, NC 28212, (704) 5683691

Chart 2 shows a dryer operating in the afternoon of its second day of drying a load of food. One can see how the temperatures increase in the top of the dryer, as the food in the top of the dryer dries. This test was not using a reflector. By the end of this day all apples slices were bone dry, almost like crackers.

Possible temperature related problems

There are a couple of potential problems associated with higher temperatures. One study reported slightly higher vitamin C loss in fruits dried at 167°F than at 131°F. Greater vitamin loss has also been reported for the direct style of food dryer which exposes the food directly to the sun's radiation (ASES, 1983). However, there are many other factors that affect vitamin loss and the losses are different for different foods and different vitamins. I need to explore this topic more fully.

Case hardening is another potential problem associated with drying at higher temperatures. If the temperature of air is high and the relative humidity is low, there is the

possibility that surface moisture will be removed more rapidly than interior moisture can migrate to the surface. The surface can harden and retard the further loss of moisture. Solar dryers start off at low temperatures and high humidity and thus avoid this problem, I believe. At least I have not observed it.

Air flow and velocity

The second of three factors affecting food drying is air flow, which is the product of the air velocity and vent area. The drying rate increases as the velocity and quantity of hot air flowing over the food increases. Natural convection air flow is proportional to vent area, dryer height (from air intake to air exhaust), and temperature. However air flow is also inversely proportional to the temperature in a solar dryer. As the air flow increases by opening an exhaust vent the dryer temperature will decrease. Ideally one would want both high temperatures and air flow. This can be difficult to achieve in a solar dryer.

Air velocity in a natural convection collector is affected by the distance between the air inlet and air exhaust, the temperature inside the dryer and the vent area. The greater the distance, temperature and vent area the greater the velocity. It is often measured in feet per minute (FPM) or meters per second. With constant temperatures, 230 FPM air velocity dries twice as rapidly as still air; at 460 FPM drying occurs three times more rapidly than in still air (Desrosier, 1963). Axtell & Bush (1991) suggest air velocities between 0.5 to 1.5 meters per second which is about 100 to 300 FPM. Desrosier (1963) suggests even higher air velocities between 300 to 1000 FPM.

The quantity of air, measured in cubic feet per minute (CFM) or cubic meters per minute, is the product of velocity and area of the exhaust vent. Morris (1981) recommends 2–4 CFM per square foot of collector for an efficient performing natural convection solar air heater. If the air flows are too slow the collector will heat

Chart 2

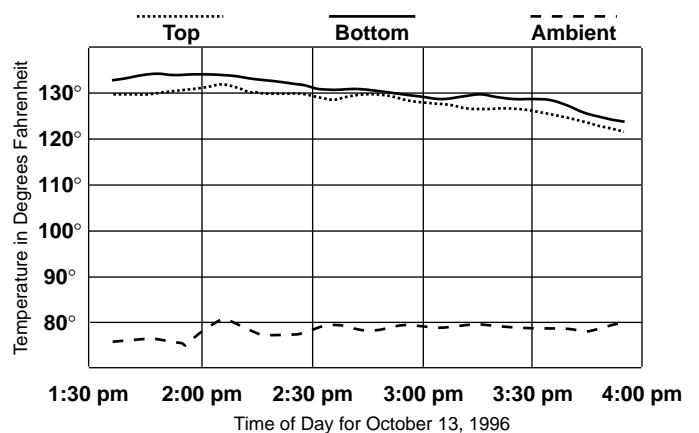

up and lose more heat to the air surrounding it. An efficient solar thermal collector should not feel hot to the touch. NTIS (1982) suggests 1/3 to 1/2 cubic meters per minute (11.5 to 17.5 CFM) per cubic meter of dryer volume as being a good flow rate for solar dryers.

Most designers of fossil fuel powered industrial food drying systems recommend considerably higher flows. Axtell & Bush (1991) of the Intermediate Technology Development Group (ITDG) recommend between 0.3 to 0.5 cubic meters per second or about 600 and 1000 CFM. Desrosier (1963) recommends 250 CFM per SF of drying surface. For the dryer described in this article with 18 SF of drying surface that would equal a little over 4,500 CFM.

Measured air velocities and flows in the Appalachian dryer

Our solar dryers are only able to achieve air velocities between 50 and 130 FPM with natural convection. Less than most of the 100 to 1000 FPM range recommended. Air velocities were measured in the solar collector's air flow channel with a Kurtz 490 series mini-anemometer.

Our dryer also has less total air flow than is recommended by most. During normal operation it allows 25–60 CFM. A tremendous difference from the 600 to 4500 CFM recommended for industrial drying systems. It has around 9 SF of glazing and should allow, according to Morris, 18 to 36 CFM for efficient collector performance. Our drying volume is about 3 cubic feet (0.08 cubic meters) and would according to NTIS need between 1 to 1.5 CFM. Quite a bit less than recommended by Morris for efficient collector performance and also less than our dryer's normal operating performance.

Increasing air flows and air velocity seems to have potential for increasing the performance of solar dryers. Unfortunately as the air flow increases the temperature

decreases in a solar dryer. Chart 3 depicts the temperature decline when the vents are fully opened from a 1 1/2" opening and then almost fully closed. We have found temperature to be more significant than air flow in affecting the speed or rate of drying and so we usually reduce the air flows by partially closing the exhaust vents to increase the temperature. By increasing the power or performance of our solar collector greater air flows will be possible while maintaining high temperatures.

Relative Humidity

While not something one can do much about, the relative humidity is the third factor affecting food drying. The higher the humidity the longer the drying will take. More air will be required and the temperatures will need to be higher. Each 27°F increase in temperature doubles the moisture holding capacity of the air (Desrosier, 1963). In the Appalachian region where we have tested our dryers we normally have a relative humidity throughout the summer and early fall of 55 to 100%. This moist air can't hold as much moisture as less humid air could and as a result drying takes longer than it might in a dryer climate. This humidity also makes higher temperatures desirable for our climate.

How to get the correct temperature and air flow

The temperature obtainable in the dryer will be affected by several things: area of south facing glazing, insulation, air-tightness, area of vent opening, and ambient temperature. The area of south facing glazing is an important design decision. The dryer pictured has 9.2 SF of south facing glazing and approximately 3 CF of drying volume or 3 SF of glazing for every 1 CF of drying chamber. This is a good ratio. If one is interested in drying speed, increasing the ratio of glazing SF per cubic foot of dryer volume, adding more insulation and/or adding a reflector to the dryer would be desirable. This will allow one to increase the temperatures, air velocities and total air flow; and decrease the drying time. The temperature rise in the dryer described can be as high as 125°F above ambient with a reflector and all vents closed. Normal temperature rises without a reflector and with both exhaust vents opened 1–3" (12–36 square inches) would be 50 to 70°F. As mentioned previously, our preliminary testing indicates about a 20°F increase in temperature by adding a reflector. The maximum temperature observed was 204°F. The higher Delta T's and maximum temperatures will be reached with exhaust vent opening area reduced.

Designing for good air flows involves quite a few considerations. The air flow channel should be properly sized. The depth of the channel should be 1/15 to 1/20th the length of the collector. Making the air flow

Chart 3

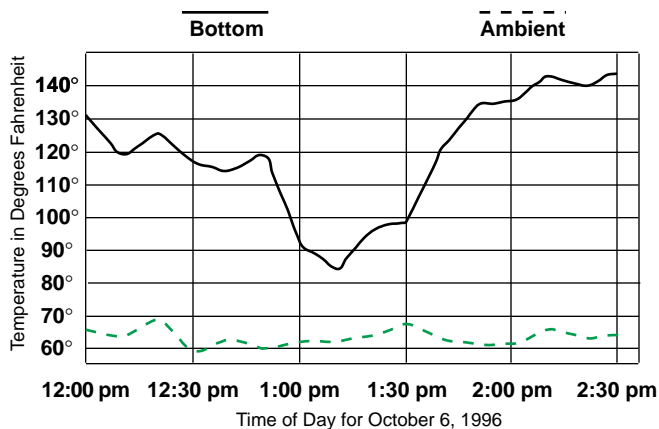

path as aerodynamic as possible is also desirable; especially for a natural convection collector. Although turbulence created by fins on the back of an absorber plate or corrugated metal has been shown to deliver as much as 40% more heat in active systems (Morris, 1981). One should try to keep the intake and exhaust vents spread as evenly as possible along the width of the collector to allow easy air movement. The intake and exhaust area and profile should ideally be the same or larger than the air flow channel. Air flow rates can be increased, while keeping temperatures up between 140°F and 175°F, by constructing a larger, more efficient, better insulated collector and/or adding a reflector to the collector. Increasing the size and/or performance of the collector can also increase air velocity by increasing the temperature inside the dryer. A larger, more efficient or powerful collector will allow one to more fully open up the vents thus increasing the CFM or volume of air moving through the dryer, while still keeping the temperatures high in the dryer. The dryer described here has 2 exhaust vents with a total of about 1.6 square feet of exhaust vent area. With the vents completely open the maximum temperature attainable on a sunny 70°F day is only about 85°F and so we normally decrease the vent area and CFM of air flow to increase the temperature and decrease the drying time. The area of exhaust vent during normal operation for several dryers we have designed and constructed is 10 square inches or less. This enables the dryer to achieve temperatures over 130°F and still allow air flow. It is desirable to have adjustable vent covers so one can adjust for different foods and weather conditions. Ideally the temperature in a food dryer should be controllable. The air velocity could also be improved by adding a fan, possibly PV powered as has been discussed in a previous HP article, or tall chimneys. Adding chimneys to a dryer and increasing the distance between the air inlet and exhaust will increase the velocity and volume of air moving through the dryer.

Collector design

The dryer uses a "Through Pass" collector configuration. Solar energy passes through a glazing material and is absorbed by 5 layers of black aluminum window screening diagonally positioned in the air flow channel. The air around the absorber, the black screen, is heated and rises into the drying chamber. A slight vacuum or negative pressure is created by the rising air which draws in additional air through the inlet vent and the aluminum mesh absorber. This air is heated and the process continues (Illustration 1).

Through pass mesh type absorbers can outperform plate type absorbers by quite a bit if properly designed because the air must pass through the mesh resulting

Illustration 1

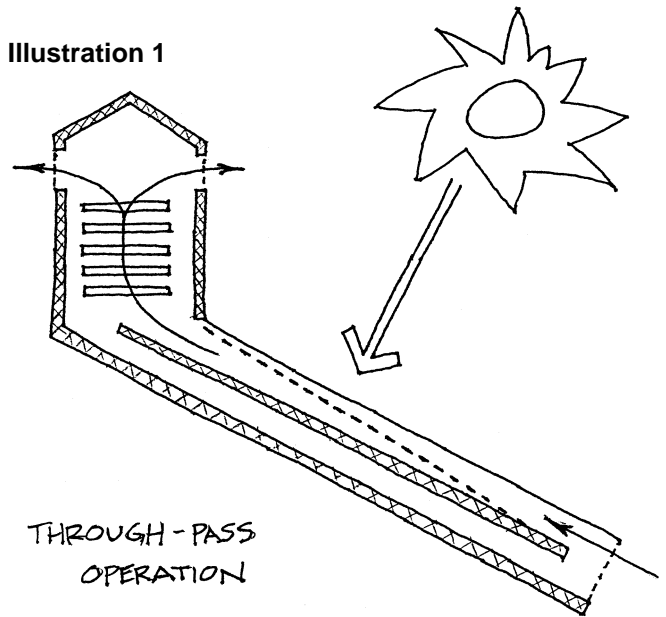

in excellent heat transfer (Morris, 1981). At Appalachian State we have compared the various absorber plate configurations and have found the diagonally positioned mesh type absorbers to produce the highest temperatures inside a box connected to the collector. Expanded wire lathe is recommended by some for the mesh but needs to be painted and didn't perform any better in our tests than the window screening. Using stock black or dark gray aluminum window screen eliminates having to paint the absorber and is less expensive and time consuming than other options. The bottom of the air flow channel can be painted black or some dark color to absorb any solar energy that gets through the mesh or possibly painted a light or reflective color to reflect sunlight back on to absorber mesh. Morris (1981) recommends a dark color, when we experimented with this we found similar performance with both strategies.

Another characteristic of our collector is its U-tube design. In addition to the air flow channel right below the glazing, there is a second air flow channel right below the first one and separated by a 1/2" thick piece of polyisocyanurate foam insulation board. This allows air to circulate when the vents are closed to increase the temperatures for pasteurization or to recycle air that has not absorbed much moisture in the latter stages of drying (Illustration 2).

When the vents are open most air will be drawn up in the top air channel and the bottom channel helps to reduce heat loss to the outside through the bottom of the dryer. The measured air flow velocity in this bottom channel was about 15 FPM with the two exhaust vents

Illustration 2

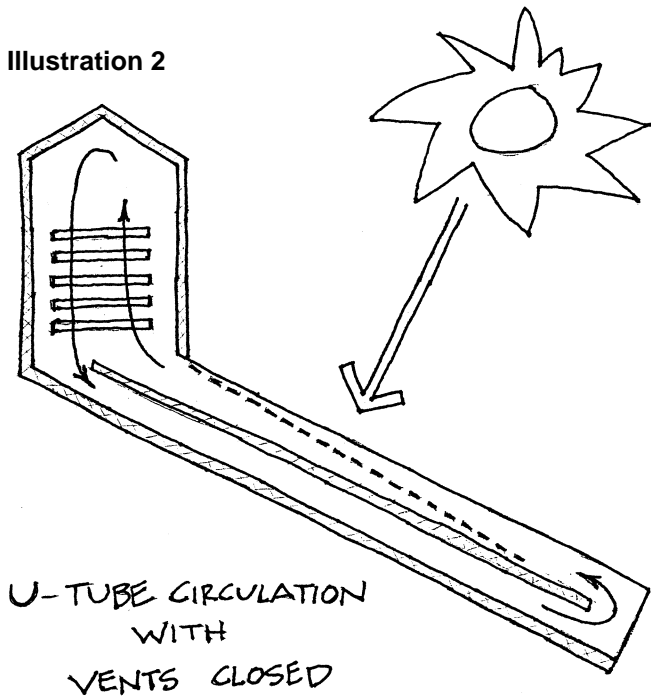

open 1.5" each and went up to about 25 FPM when all vents were closed. This seems to support the recycling theory. I'm not sure this feature is necessary; but, it doesn't seem to hurt the performance and may be helpful some times. We need to look at this some more.

One significant decision, in addition to size, which needs to be made when designing an air heating solar collector is what depth should the air flow channel be. The air flow channel depth for a through pass collector should be 1/20 the length of the collector (Morris, 1981). The collector pictured is 60" long and has a 3" air deep air space (1/20 x 60") in both air flow channels.

Any kind of glazing will work for this design. Appalachian's dryer has two layers of glazing; the outer is Sun-Lite HP, a fiberglass reinforced polyester (FRP), often referred to as Kalwall. It is available from Solar Components Corporation for about \$2.00/SF (121 Valley Street, Manchester, NH, 03103-6211, (603) 668-8186). The inner glazing is Teflon manufactured by the DuPont Company, (Barley Mill Plaza 30-2166, P.O. Box 80030, Wilmington, DE 19880-0030, (302) 892-7835). There is a 3/4" air space between the two layers and the glazings are caulked in place. The dryer should face due south for best stationary performance. The altitude angle of the glazing above horizontal should be the compliment of the average noon altitude angle of the sun at your latitude for the months you expect to be using the dryer or your latitude minus 10°, if you primarily intend to use it during the later part of the summer and early part of fall. For our latitude here in Boone, NC of 36° that would be 26°. The dryer pictured has an angle of 36°.

The sides and bottom of the collector and the sides,

door and top of the drying chamber are insulated with 1/2" Celotex Tuff-R polyisocyanurate foam insulation. It normally is covered with an aluminum foil. I am going to use 3/4" in the next one constructed. Making sure you tightly construct the collector by making good tight fitting joints, especially the door, and using caulks and/or gasket material is also desirable. And finally adding a reflector to the dryer and properly positioning it (about 20° above horizontal in early October to 40° in mid July at 36° N LAT) will improve the performance.

Materials Needed (approximate cost is \$150, excluding stainless steel shelf screen)

One 4' x 8' 3/4" CDX exterior plywood for sides, vent covers and door

One 4' x 8' 1/4" exterior plywood for bottom, roof and south wall of drying box

approx. 12 - 8' long 1x2 pine

Two 8' long PT 2x4 for dryer legs

Water resistant glue

Caulk or glazing tape

Eight 1/4" X 2 1/4" lag bolts and washers

24" wide by 30" long piece of black or dark gray aluminum window screen (.65/FT)

Ten 21" x 14.5" Stainless steel screen for drying shelves (\$6.62/SF) adds another \$150 to cost or could use a vinyl or vinyl clad fiberglass screen for about .35/SF

24" X 12 ft. 0.040 Sun Lite HP plastic glazing (\$1.85/SF)

Two 3 1/4" strap hinges approx.

Fifty 1 1/2" galvanized deck screws

paint

Two 2" hook and eyes

One 4' x 8' 3/4" celotex foil faced polyisocyanurate insulation board

Dryer Construction and Details

The dryer is primarily constructed of 3/4" exterior plywood, 1/4" exterior plywood, 3/4" celotex insulation board, dark aluminum screening, glazing, some 3/4" thick pine boards, and wood screws. The cutout illustrations (Illustration 3 & 4) dimension the layout of the important plywood and insulation pieces.

I tried to improve on the design depicted in this article by slightly increasing the glazed area (from about 9 to 10 SF), the SF/CF ratio (from 3 to 3.5 SF/CF), the thickness of insulation used (1/2" to 3/4") and lowering the collector altitude angle (from 36° to 26°) to improve late summer and early fall performance. I am also going to develop a larger and more permanent adjustable reflector. Verify the measurements before blindly cutting

Illustration 3

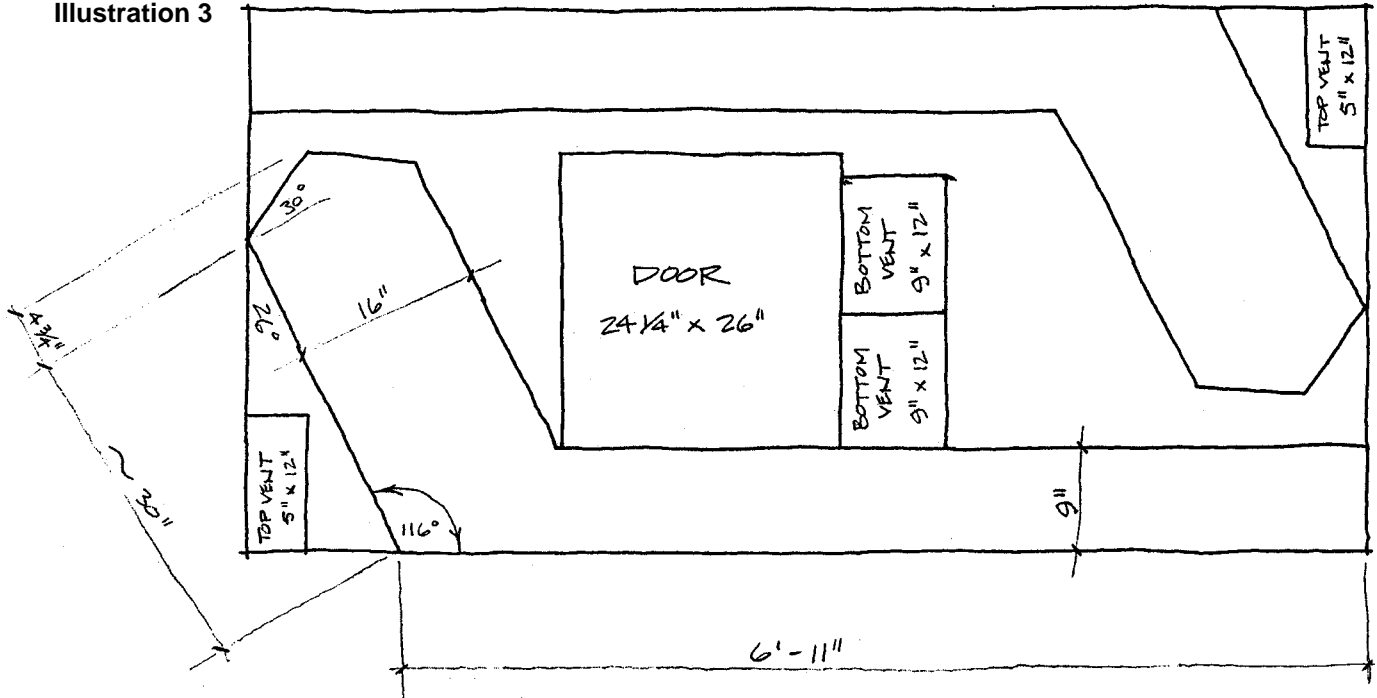

3/4" PLYWOOD LAYOUT

Illustration 4

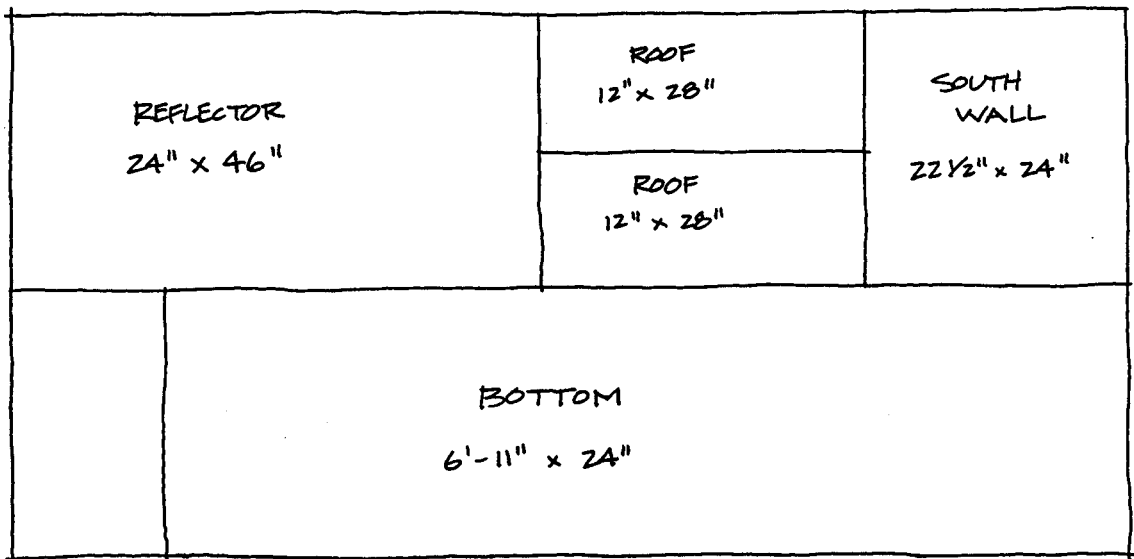

1/4" PLYWOOD LAYOUT

Illustration 5

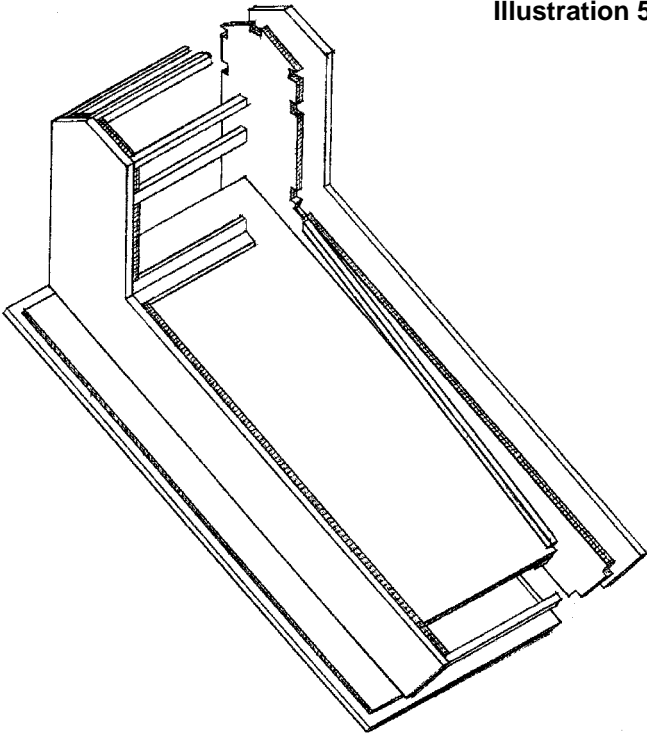

everything out. I tried to be as accurate as I could; however, there may be some mistakes. The exploded isometric drawing (Illustration 5) and the multiview (Illustration 6) illustrate the basic construction.

Basically begin by laying out the dryer sides, the door and the vent pieces on the 3/4" plywood. Cut these out with a skill or jig saw. Cut the 1/4" plywood bottom out with skill saw. Use the plywood side pieces to layout the insulation board dryer side pieces and cut with a razor knife. Glue the insulation to the plywood sides and then connect the sides together by gluing and screwing or nailing the plywood bottom on and screwing the 22 1/2" long wooden struts made from 1x2 stock in place. Illustration 7 describes the location of the most critical struts. Cut out insulation where the struts join the side pieces. Once the basic form is constructed everything else is applied as depicted in plans and photos.

Using the dryer

1) The initial phase of drying is more dependent on air flow than temperature, so keep the bottom vents completely open and the top about 1/2 open or more. After 1 to 2 hours reduce the top exhaust vent opening to 1"-3", leaving the bottom vents completely open, and

Illustration 6

APPALACHIAN SOLAR
FOOD DRYER

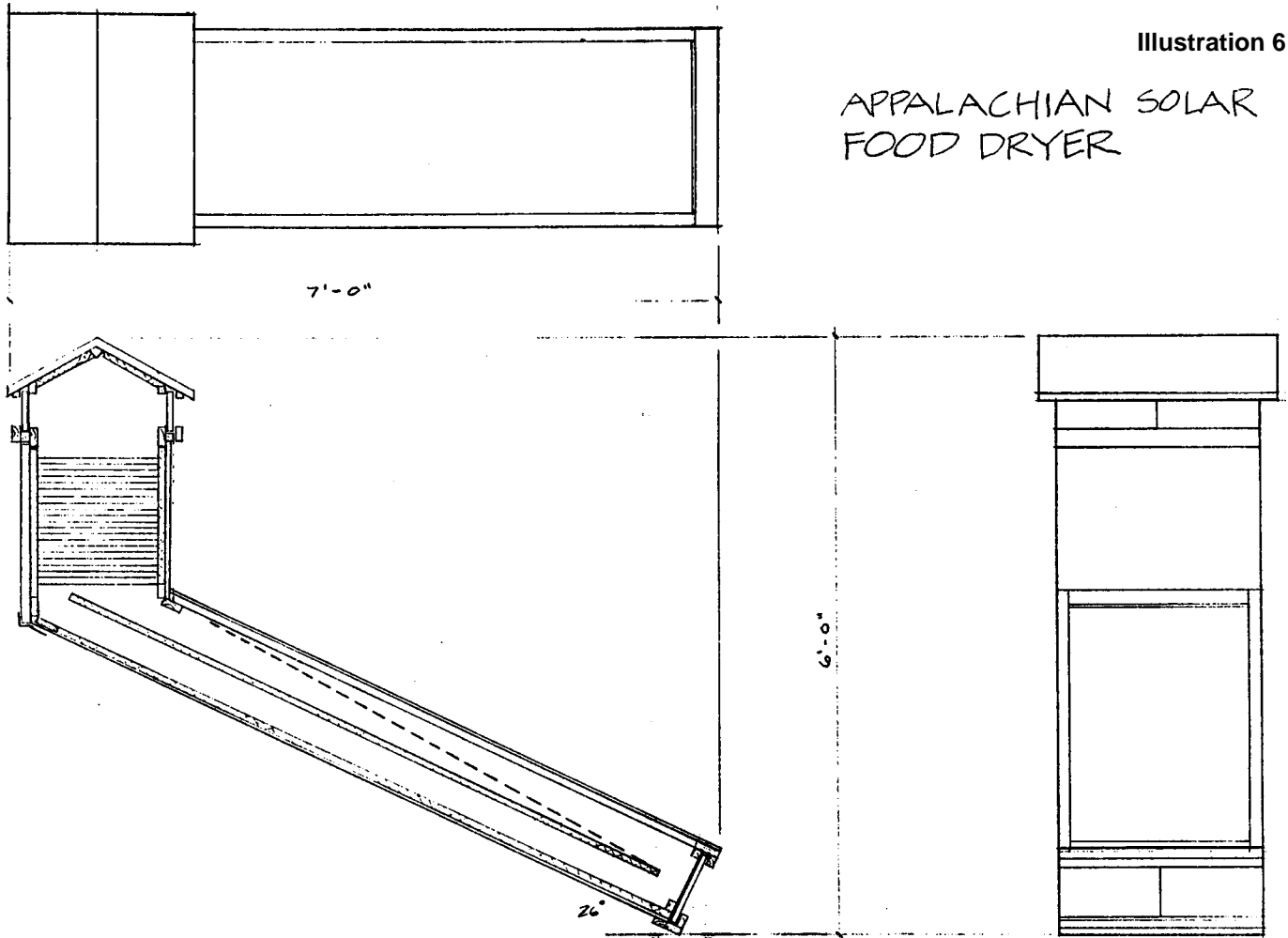

let the temperature rise. Keep the dryer under 180° F. Close all the vents at night to prevent rehydration of any food left in dryer. On cloudy days keep the bottom vents closed and the top vents almost closed to keep temperatures as high as possible.

2) Keep everything as clean as possible; wash food gently in cold water 3) Get fruit and/or vegetables in dryer as quickly as possible after harvesting to preserve vitamins

3) Remove blemished and woody areas of fruits and vegetables

4) Consider blanching most vegetables, by exposing to steam for a few minutes and then dipping in ice water, to inactivate enzymes which can cause color, flavor and nutritional deterioration. Blanching helps preserve carotene, thiamine, and ascorbic acid. Blanching also makes cell membranes more permeable, which promotes more rapid drying and will kill potentially harmful micro-organisms. The blanched dried product will often have a softer texture when rehydrated. Blanching apricots, peaches and pears imparts a translucent appearance to the dehydrated product and

Illustration 7

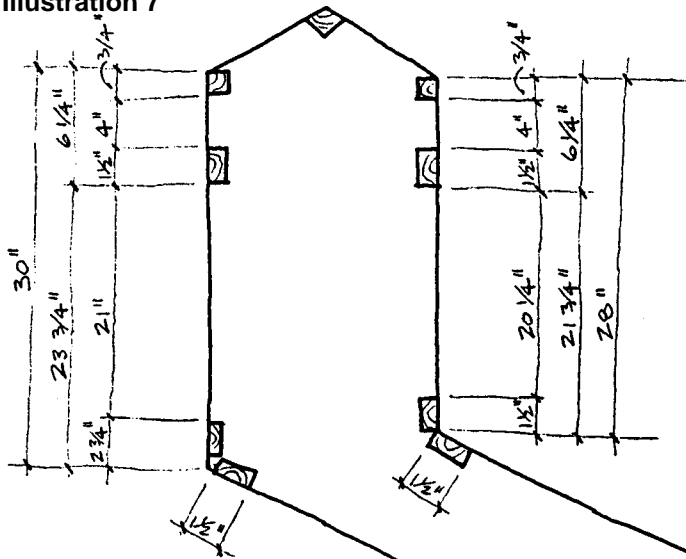

STRUT LAYOUT

can also be used for fruits which will not have detrimental color changes during drying: grapes, figs, plums and prunes. Don't blanch onion, garlic, mushrooms, horseradish, herbs, or vegetables with cabbage like flavors

5) Consider sulfuring fruits. Sulfuring helps preserve the light color of apples and apricots and also helps preserve ascorbic acid (C), and beta-carotene (A), and helps control microbiological and insect activity. It also protects delicate flavors and increases the shelf life of dried foods. Sulfuring involves burning elemental sulfur and exposing the fruit to the fumes for 1-5 hrs or dipping the fruit for 30 seconds in a 5-7% potassium metabisulfate solution. When fruit has been adequately sulfured the surface will be lustrous. Pretreating tomatoes with potassium metabisulfate prior to drying has been reported to significantly improve the taste and aroma of sauce made from the dried tomatoes. Sulfur flowers are available at pharmacies or use pure sulfur from garden centers. Use 1 tbs/lb of fruit. Thiamine is destroyed by sulfuring.

6) Slice food thin (1/8") for most rapid drying and cut uniformly.

7) Most vegetables should be dried until they feel distinctly dry and brittle, around 10% MC.

8) If drying meat use lean meat, cut into very thin strips and marinate before drying. Beef, turkey, chicken, and salmon can all be dried.

9) If drying fish keep temperatures under 131°F to avoid cooking it and consider salting 1-2 days before drying. Salting retards bacterial action and aids in the removal of water by osmosis.

10) The safe maximum percentages of water to leave in home dried produce are: no more than 10% for vegetables and no more than 20% for fruits (Hertberg et al., 1975). Fruit can be considered dry when it is leathery, suede-like, or springy. No wetness should

come out of a cut piece when squeezed. A few pieces squeezed together should fall apart and spring back when pressure is released. Vegetables should be brittle, or tough to brittle almost crisp like crackers or potato chips.

11) Put screen over the intake and exhaust vents to keep insects out.

Tips for Storing Dried Foods

- 1) Cool food to room temperature before packaging
- 2) Store dry fruits and vegetables in small, airtight, moisture, insect and rodent proof containers in dark, cool, dry and clean places. Glass jars, plastic bags, or plastic containers that can be sealed tightly are good. Store grains, roots, and legumes in places with good air circulation (NTIS, 1982).
- 2) Dried meats and fish should be stored below 5°C (41°F) to avoid rancidity (NTIS, 1982).
- 3) Most fruits and vegetables will keep for 6 months if stored at 70°F and 3-4 times that long at 52°F (Wolf, 1981).
- 4) Meat and Fish can be stored dried for several months in moisture proof, airtight containers. (Wolf, 1981)
- 5) If drying herbs store in uncapped jars for 24 hrs, if moisture collects, herbs need additional drying
- 6) Refrigeration or freezing will extend life of dried food.
- 7) Carefully label the food.

Influence of dehydration on nutritional value of food

While all methods of food preservation result in a degradation of the food quality and drying is no exception, drying food does increase the concentrations of proteins, fats and carbohydrates. Fresh peas are 7% protein and 17% carbohydrates; dried peas 25% protein and 65% carbohydrates. Fresh beef is 20% protein and dried is 55%. There is; however, a loss of vitamins. The extent of vitamin loss will be dependent upon the caution exercised during the preparation of the food for drying, the drying process selected, and storage of dried food. In general indirect drying methods such as the dryer described in this article retain more vitamins than sun drying or direct drying and also better than canning. Ascorbic acid, and carotene can be damaged by oxidative processes. Thiamin is heat sensitive and destroyed by sulfuring. The carotene content of vegetables is decreased by as much as 80% if dried without enzyme inactivation by blanching or sulfuring. Thiamin will be reduced by 15% in blanched vegetables and up to 75% in unblanched. In general more rapid drying will retain more ascorbic acid than slow drying. Usually dried meat has slightly fewer vitamins than

fresh. Fruits and vegetables are generally rich sources of carbohydrates and drying, especially direct sun drying, can deteriorate carbohydrates. The addition of sulfur dioxide is a means of controlling this deterioration.

Influence of drying on Micro-organisms

Living organisms require moisture; so by reducing the moisture we are able to reduce the ability of molds, bacteria, and yeasts from growing. Bacteria and yeasts generally require moisture contents over 30%. Drying food lower than 30% is no problem in a solar dryer. Molds however can grow with as little as 12%. Molds also require air, so as long as dried food is stored in an airtight container molds should not be a problem. Also if food was dried at over 140°F or if it was pasteurized prior to and after drying all 4 of the problem causing agents will be destroyed. Salt can be also used to control microbial activity if drying fish or meat. It is also important to start with clean food and utensils, and store food away from dust, rodents, insects and humidity.

Influence of drying on Enzyme activity

Enzymes are produced when plant tissues are damaged. Their production can lead to discoloration, loss of vitamins, and breakdown of tissues. Most enzymes are inactivated at 158°F. They also require moisture to be active and their activity decreases with decreasing moisture. But dried food still has some moisture so food deterioration due to enzymes can still be a problem. Browning of fruit for example and loss of carbohydrate content. One minute of moist heat at 212 F will inactivate enzymes. This can be achieved by blanching. Sulfuring also deactivates enzymes. Surprisingly dry heat does not affect enzymes very much. Short exposures to a dry 400°F has little effect. Blanching times vary. In general 1–3 minutes for leafy vegetables, 2–8 for peas, beans, and corn and 3–6 for potatoes, carrots, and similar vegetables.

Access

Author: Dennis Scanlin, 3137 George's Gap Road, Vilas, NC 28692 • 704-297-5084
Internet Email: Scanlindm@conrad.appstate.edu

Sun-Lite HP glazing is available from Solar Components Corporation, 121 Valley Street, Manchester, NH 03103-6211 • 603-668-8186

Teflon glazing is manufactured by the DuPont, PO Box 80030, Wilmington, DE 19880-0030 • 302-892-7835

Reference List

American Solar Energy Society (1983). Progress in Passive Solar Systems. Boulder, Colorado: American Solar Energy Society, p. 682.

Axtell, B.L. & Bush, A. (1991) Try dying it!: Case studies in the dissemination of tray drying technology. London, UK: Intermediate Technology Publications.

Desrosier, N.W. (1963). The technology of food preservation. Westport, Conn.: Avi Publishing.

Hertzberg, R., Vaughan, B., & Greene, J. (1976). Putting Food By. New York: Bantam.

International Labour Office (1986). Practical methods of food preservation.

Martinez, P.S. (1985). Production characteristics of a solar heated drying plant. Sunworld, 13(1,19), 19-21.

Morris, S. (1981). Retrofitting with Natural Convection Collectors. In T. Wilson (Ed.), Home Remedies: A Guidebook for Residential Retrofit (pp. 152 - 161). Philadelphia, PA: Mid-Atlantic Solar Energy Association.

National Technical Information Service (NTIS). (1982). Improved Food Drying and Storage; a training manual.(report no. A360.33). Washington, DC: U.S. Peace Corps.

Winter, Steven & Associates, Inc. (1983). The Passive Solar Construction Handbook. Emmaus, Pa: Rodale Press.

Wolf, R. (1981). Solar Food Dryer Preserves Food for Year-Round Use; Using Solar Energy. Emmaus, PA: Rodale Press.



SNORKEL STOVE CO

camera ready b/w
3.5 wide
3.4 high



Danby[®]

"Good things come in small packages"

Dealer
Inquiries
Invited

- **7.8 cu. ft. Capacity Refrigerator.**
- **Reversible Door Hinges.**
- **Door Liner has large, functional divisions, plus a molded Egg Rack.**
- **Tall Upper Shelf accommodates 1 & 2 gal Jugs.**
- **3 Easy-glide Shelves and a Large Crisper.**
- **Battery Powered Refrigerator Light.**
- **Automatic Lighter (piezo-electric)**
- **Automatic Safety Valve.**
- **European Style Door with Recessed Handles.**
- **Refrigerator is AGA & CGA Approved.**
- **No Electricity Needed.**

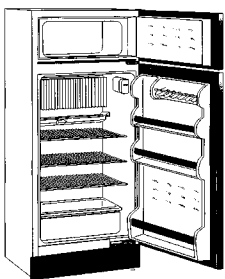

Propane Refrigerator DPR2260

\$995.00

Plus Shipping

(800) GO-SOLAR (467-6527) nrgoufit@cdsnet.net
136 S. Redwood Hwy, POB 1888, Cave Junction, OR 97523
Web Page: <http://www.energyoutfitters.com>



The new
Wind Baron 750 XLM™
By **WSW Systems**
Call Toll Free
1-800-633-WIND

BUY DIRECT
\$1195
AND SAVE

The Wind Baron line of small wind turbines developed new technology in achieving the highest current outputs from a small, lightweight wind turbine system. We first introduced neodymium iron boron magnets to the small wind turbine industry. We followed this with new tri-blade lightweight wood propeller designs. New over speed controls and on/off switches were then introduced. Now we have achieved the ultimate, with computer balanced innovative rotors and matched stators that cannot be duplicated by any other technology. The output at all wind speeds cannot be matched by any other wind turbine system in this size category. With over 3,000 working systems in place throughout the world you can count on the Wind Baron for reliability and value. Please call our toll free number today for your free brochure from our fax on demand system. 1-800-633-WIND

"We make renewable energy work for you"

IMPROVING SOLAR FOOD DRYERS

Dennis Scanlin,
Marcus Renner,
David Domermuth, &
Heath Moody

©1999 Dennis Scanlin, Marcus Renner,
David Domermuth, and Heath Moody

Above, Photo 1: Three identical solar food dryers for testing against a control.

This article describes a series of experiments conducted over the last year and a half with three solar food dryers. The food dryers were constructed at Appalachian State University (ASU) using plans published in *HP57*. The goal of this research program was to improve the design and to determine the most effective ways to use the dryer.

Figure 1: Cutaway View of the Appalachian Solar Food Dryer

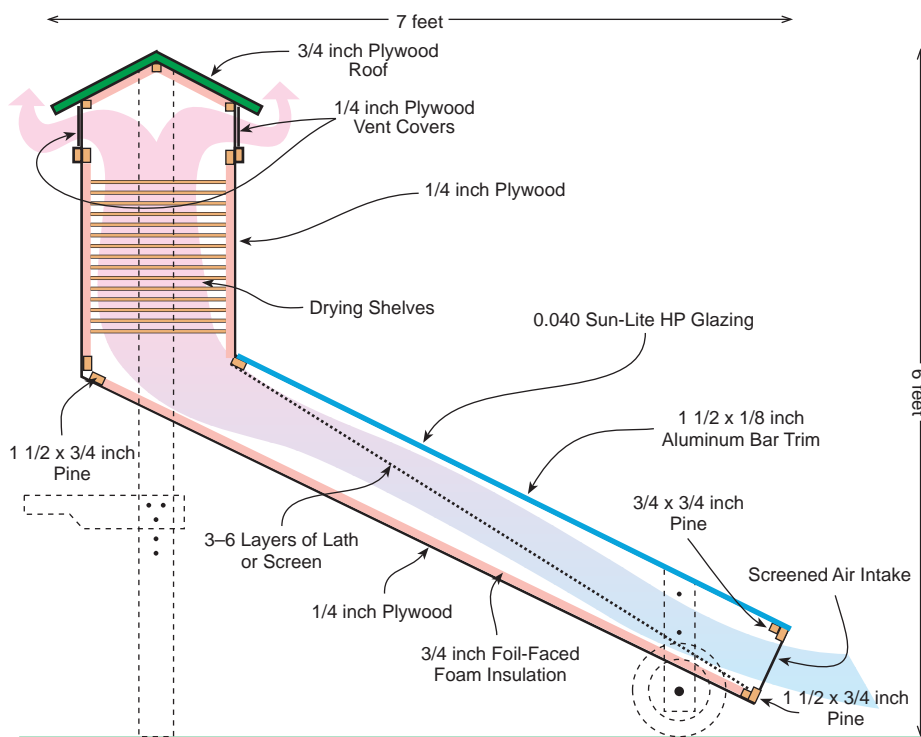
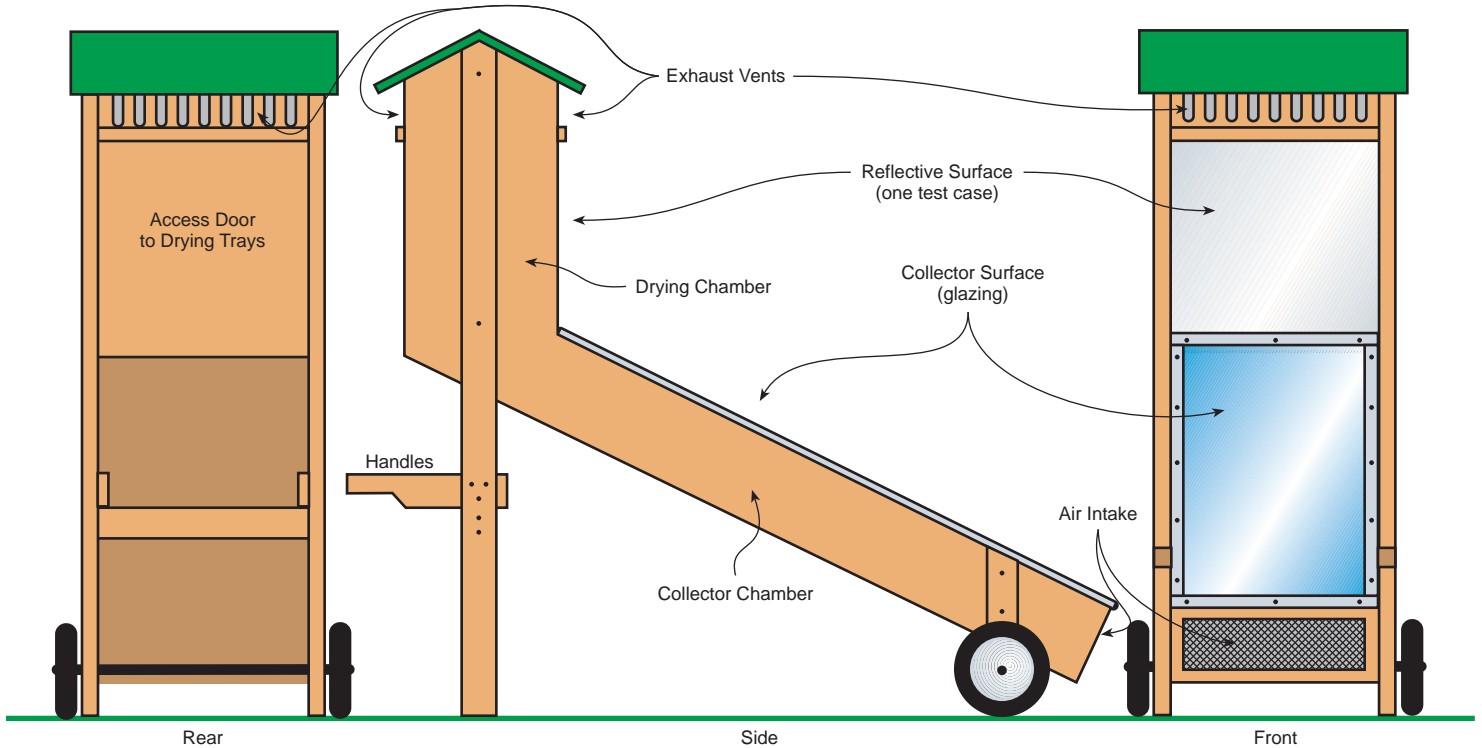

Figure 2: Multiple Views of the Appalachian Solar Food Dryer



These solar food dryers are basically wooden boxes with vents at the top and bottom. Food is placed on screened frames which slide into the boxes. A properly sized solar air heater with south-facing plastic glazing and a black metal absorber is connected to the bottom of the boxes. Air enters the bottom of the solar air heater and is heated by the black metal absorber. The warm air rises up past the food and out through the vents at the top (see Figure 1). While operating, these dryers produce temperatures of 130–180° F (54–82° C), which is a desirable range for most food drying and for pasteurization. With these dryers, it's possible to dry food in one day, even when it is partly cloudy, hazy, and very humid. Inside, there are thirteen shelves that will hold 35 to 40 medium sized apples or peaches cut into thin slices.

The design changes we describe in this article have improved the performance, durability, and portability of the dryer, and reduced construction costs. This work could also help in designing and constructing solar air heaters used for other purposes, such as home heating or lumber drying. Most of our experiments were conducted with empty dryers using temperature as the measure of performance, though some of our experiments also involved the drying of peaches and apples. We have dried almost 100 pounds (45 kg) of fruit in these dryers during the past year. Graduate students in the ASU Technology Department constructed the dryers, and students taking a Solar



Above, Photo 2: Setting up the solar simulator.

Solar Dehydration

Graph 1: Single vs. Double Glazing

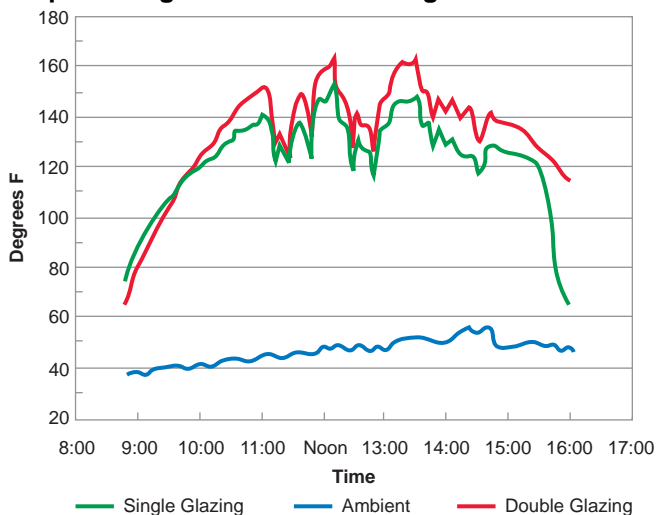

Energy Technology course modified them for individual experiments.

Methodology

We began by constructing three identical food dryers. Having three dryers allowed us to test two hypotheses at one time. For example, to examine three versus six layers of absorber mesh and single versus double glazing, Dryer One might have three layers of black aluminum window screening as an absorber with single glazing; Dryer Two, six layers of the same absorber screen with single glazing; and Dryer Three, six layers of the same absorber screen with two layers of glazing. Once we set up an experiment, we collect data. This lasts from several days to a couple of weeks until we are confident that the data is reliable. Then we try something different.

Using three food dryers also allows us to offer more students hands-on experiences with solar air heaters. Each semester, students take apart the dryers' solar collectors and rebuild them using different materials or strategies. This classwork was supplemented with experiments set up and completed by several graduate students.

Equipment for Data Collection

We have two systems for measuring temperature. The first system uses inexpensive indoor/outdoor digital thermometers. One temperature sensor is placed inside the dryer and the other one outside. Different locations are used for the sensor inside the dryer. If food is being dried, we normally place it under the bottom tray of food and out of direct sunlight. This temperature data is recorded on a data collection form every half hour or whenever possible.

The other system uses a \$600 data logger from Pace Scientific to record temperature data. It is capable of

measuring temperature, relative humidity, AC current, voltage, light, and pressure. The logger does not have a display, but it's possible to download the data to a computer. The software that comes with the logger allows us to see and graph the data. The data can also be exported to a spreadsheet for statistical analysis.

We measure air flows with a Kurz 490 series mini-anemometer. We weigh the food before placing it in the dryer, sometimes during the test, and at the end of each day. We use an Ohaus portable electronic scale, purchased from Thomas Scientific for \$111. We measure humidity with a Micronta hygrometer purchased from Radio Shack for about \$20.

Solar Simulator

In addition to outdoor testing with the actual food dryers, we use a solar simulator (see Photo 2) built by David Domermuth, a faculty member in the Technology Department at ASU. With the simulator, we can do more rapid testing and replicate the tests performed on the dryers, even on cloudy days. The simulator also lets us control variables such as ambient temperature, humidity, and wind effects. The unit can be altered quickly because the glazing is not bolted on. The simulator was constructed for \$108. It was built in the

Below, Photo 3: This dryer has both a vertical wall reflector and side reflectors.



same way as the food dryer, but without the food drying box at the top.

The simulator uses three 500 watt halogen work lights to simulate the sun. The inlet and outlet temperatures are measured with digital thermometers. The temperature probes are shaded to give a true reading of the air temperature. We conducted the simulator tests inside a university building with an indoor temperature of 62–64° F (17–18° C). As we changed variables, we noticed significant differences in outlet air temperatures. The simulator did produce temperatures comparable to those produced by the food dryers out in the sun. However, we did not always achieve positive correlations with our food dryers' outdoor performance. We may need to use different kinds of lights or alter our procedures somewhat.

Experiments

We have done at least twenty different tests over the last year and a half. All were done outside with the actual food dryers and some were also repeated with the solar simulator. The dryers were set up outside the Technology Department's building on the ASU campus in Boone, North Carolina. We collected some additional information at one of the authors' homes. Every test was repeated to make sure we were getting consistent performance. We tried to run the tests on sunny to mostly sunny days, but the weather did not always cooperate. The dips in many of the charts were caused by passing clouds.

Single vs. Double Glazing

The original design published in *HP57* used two layers of glazing separated by a 3/4 inch (19 mm) air gap. We used 24 inch (0.6 m) wide, 0.040 inch (1 mm) Sun-Lite HP fiberglass-reinforced polyester plastic for the outer layer. For the inner layer, we used either another piece of Sun-Lite, or Teflon glazing from Dupont. Sun-Lite glazing is available from the Solar Components Corporation for about \$2.40 per square foot (\$25.83 per m²). These two layers cost over \$50, or about one-third of the total dryer cost. We wanted to see if the second layer helped the performance significantly and justified the added expense.

We set up two dryers with six layers of steel lath painted flat black. One had single glazing and the other had two layers of glazing. The outer glazing was Sun-Lite HP on both dryers. The dryer with double glazing used Teflon as the inner glazing. The two dryers were identical except for the number of glazing layers. The tests were run on nine different days between February 17 and March 26, 1998. We opened the bottom vent covers completely and the top vent covers to two inches (51 mm). The ambient temperatures were cool and no food was being dried.

Figure 3: Sun Angles and Reflection with a Vertical Reflector

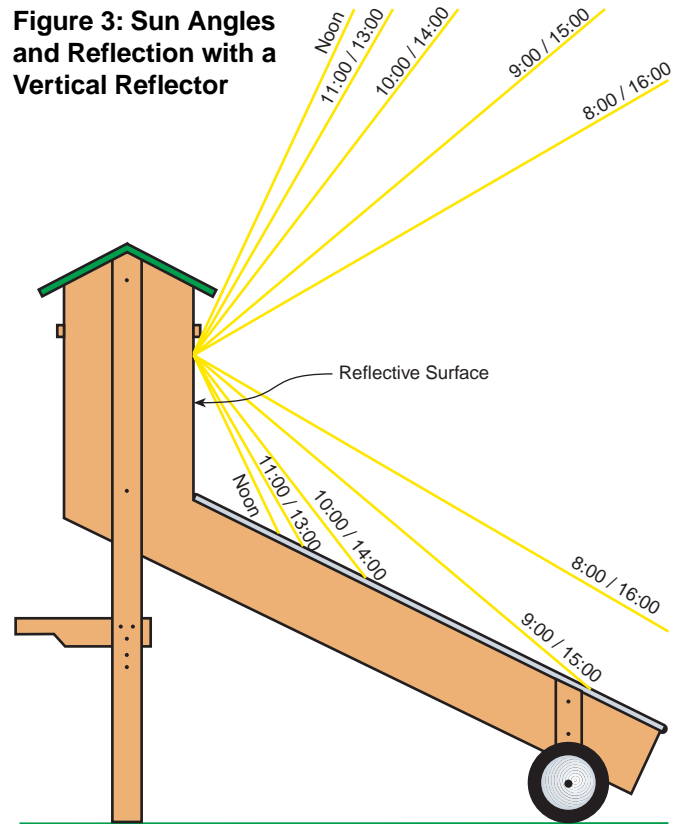

As Graph 1 shows, the double glazing did result in higher dryer temperatures. This was on a sunny day with clear blue skies and white puffy clouds, low humidity (30%), and light winds. The temperatures throughout most of the day were slightly higher with double glazing. However, the single glazed dryer works well and routinely reached temperatures of 130–180° F (54–82° C). When this test was replicated with the solar simulator, the double glazing also produced slightly higher temperatures.

Our conclusion is that double glazing is not necessary for effective drying. It does reduce some heat loss and increases the dryer's temperature slightly, but it increases the cost of the dryer significantly. Another problem is that some condensation forms between the two layers of glazing, despite attempts to reduce it by caulking the glazing in place. The condensation detracts from the dryer's appearance and may cause maintenance problems with the wood that separates the two layers of glazing.

Reflectors

One possible way to improve the performance of these dryers is to use reflectors. We tried several strategies: making the vertical south wall of the dryer box a reflective surface, hinging a single reflector at the bottom of the dryer, and adding reflectors on each side of the collector.

Graph 2: Vertical Wall Reflector vs. No Reflector

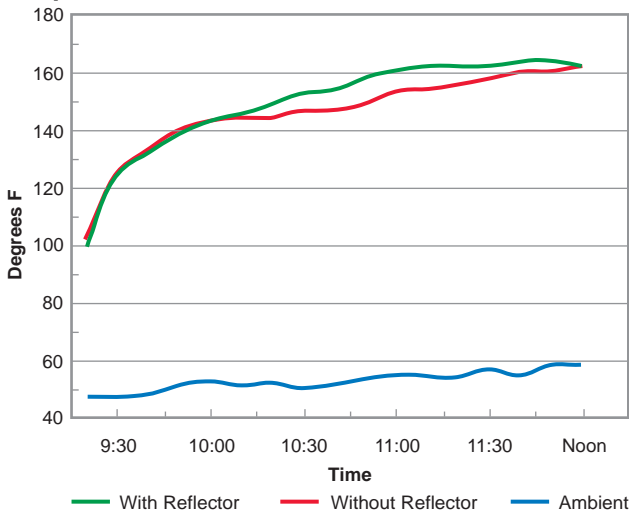

Look at the temperatures recorded on Graph 2. A slight increase in dryer temperature was recorded in the dryer having the south-facing reflective wall. The reflected light covers the collector most completely at mid-morning and afternoon. As the sun gets higher, the light is reflected onto a smaller area of the collector.

Single Reflector

A single reflector was hinged to the bottom of the collector (see Photo 4). This reflector was supported with a string and stick arrangement, similar to one used by Solar Cookers International. With all reflector systems, the dryer has to be moved several times throughout the day if performance is to be maximized. This allows it to track the azimuth angle of the sun. The altitude angle of the reflector also needs to be adjusted during the day from about 15° above horizontal in the

Vertical Wall Reflector

We realized that the vertical south wall of the dryer box could be painted a light color or coated with aluminum foil, a mirror, or reflective Mylar (see Photo 3). A vertical south-facing wall reflector would reflect some additional energy into the dryer's collector, protect the wood from cracking, and prevent deterioration from UV radiation. Considering the fact that the angle of reflection equals the angle of incidence, we were able to model the performance of this reflector, using a protractor and a chart of sun altitude angles (see Figure 3). If the dryer is moved several times throughout the day to track the sun's azimuth angle, then the reflector concentrates some additional solar energy onto the dryer's collector during most of the day.



Above, Photo 4: Setting the front reflector angle.

Figure 4: Single Reflector at Low Sun Angle

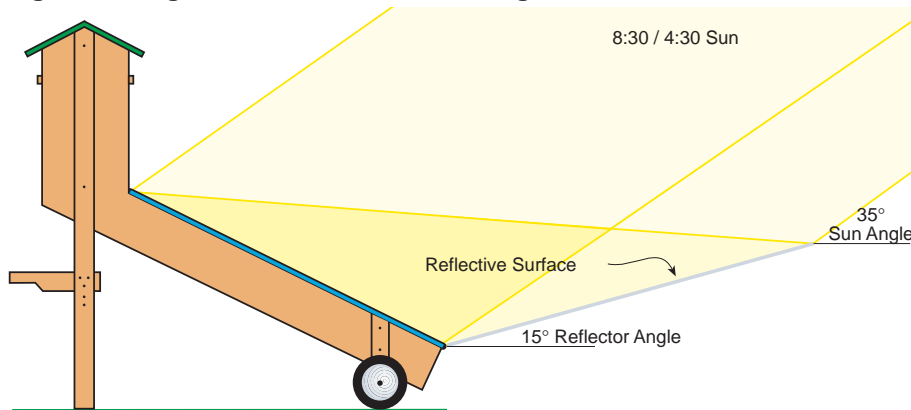

morning and evening to 45° above horizontal around noon (see Figures 4 and 5). The reflector added 10–20° F (2.4–4.8° C) to the temperature of the dryer and removed slightly more moisture from the food than a dryer without a reflector.

Side Mounted Reflectors

A third strategy was to add reflectors to both sides of the collector. This captures more solar energy than the

Figure 5: Single Reflector at High Sun Angle

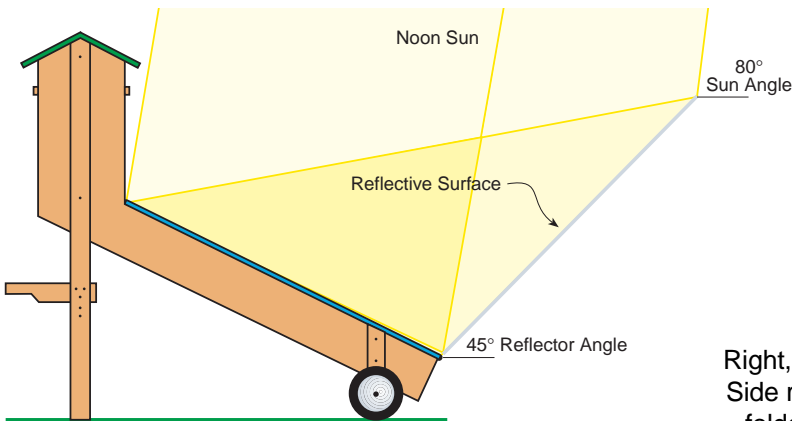

other two strategies. We determined that the ideal reflector angle would be 120° from the collector surface (see Figure 6). This assumes that the dryer is pointing toward the sun's azimuth orientation.

We performed an experiment to compare a dryer with two side reflectors and a vertical wall reflective surface with a dryer having no reflectors (see Photo 3). Both dryers were moved throughout the test period to track the sun. The reflectors were mounted with hinges and could be closed or removed when transporting the dryer (see Photo 5). Graph 3 shows the significant increase in temperatures attained by using these reflectors. The problem with this design was that if the dryer could not track the sun for one reason or another, one of the

Figure 6: Ideal Angle for Side-Mounted Reflectors

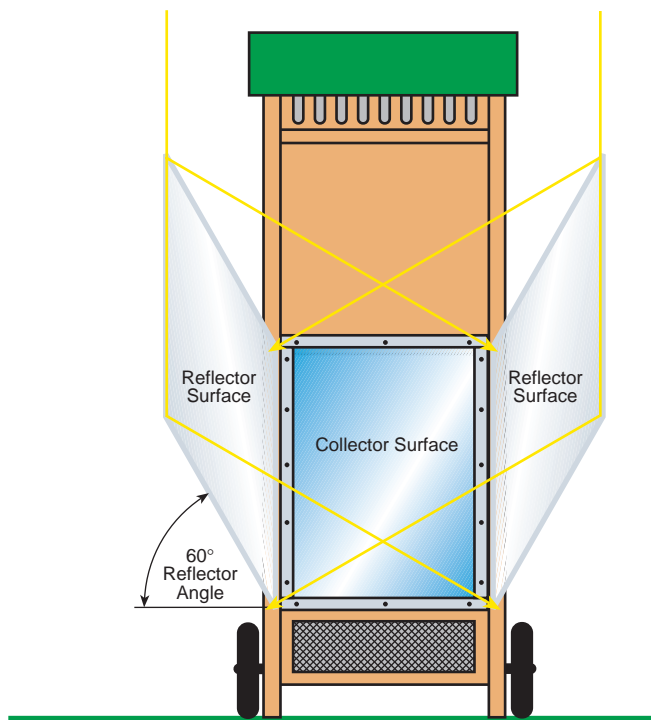

Right, Photo 5: Side reflectors folded onto glazing for transportation.

reflectors would shade the collector in the morning and the other in the afternoon.

We concluded that the vertical wall reflector and the single reflector mounted to the bottom of the collector are the best ways to add reflectors, since tracking is not crucial in these applications. However, these dryers routinely attain temperatures of $130\text{--}180^\circ\text{ F}$ ($54\text{--}82^\circ\text{ C}$) without reflectors, which is hot enough for food drying and for pasteurization. Based on our work so far, reflectors just don't seem to be worth the trouble.

Absorbers

All low temperature solar thermal collectors need something to absorb solar radiation and convert it to heat. The ideal absorber is made of a conductive material, such as copper or aluminum. It is usually thin, without a lot of mass, and painted a dark color, usually black. The original dryer design called for five layers of

Graph 3: Vertical Wall & Side Reflectors vs. No Reflector

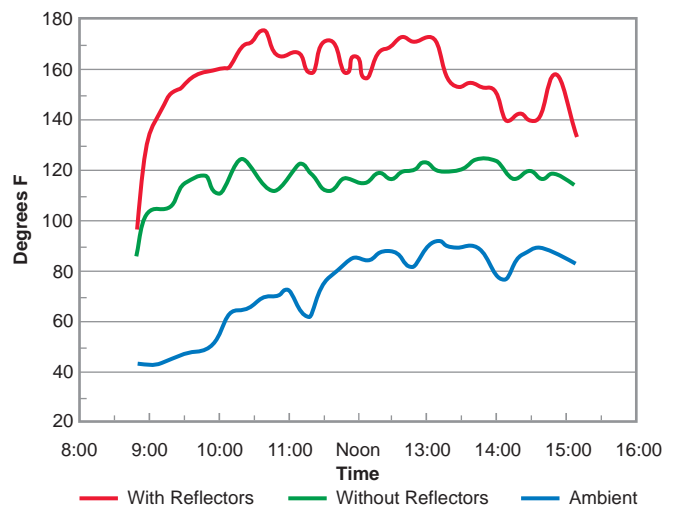
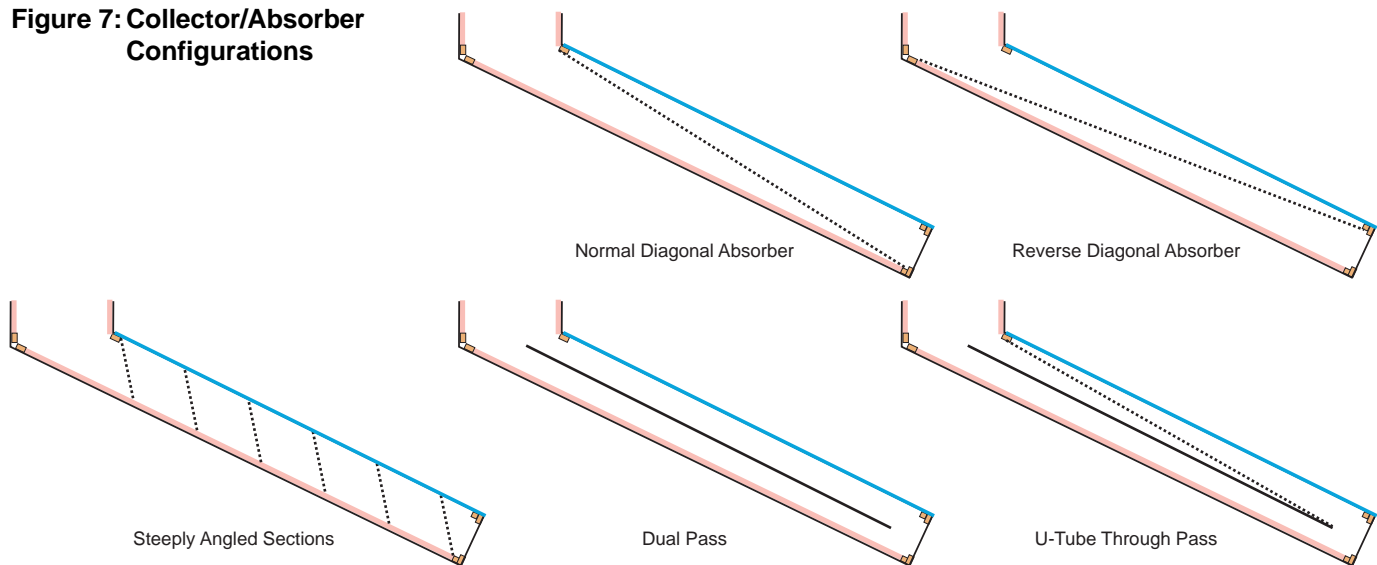

Figure 7: Collector/Absorber Configurations



black aluminum window screening, which had proven to work well in other air heating collectors we had constructed. Other designs call for metal lath, metal plates such as black metal roofing, or aluminum or copper flashing. We decided to try some different materials and approaches to see if we could come up with a better absorber.

Plate vs. Screen

First, we compared five layers of black aluminum window screen placed diagonally in the air flow channel to one piece of black corrugated steel roofing placed in the middle of the channel (see Figure 7). We found that the mesh produced temperatures about 7° F (3.9° C) higher than the roofing in full sun. Other experiments have shown that mesh type absorbers are superior to plate type absorbers. These differences might be reduced if we used a copper or aluminum plate instead of the steel roofing.

Graph 4: Lath vs. Screen Absorber

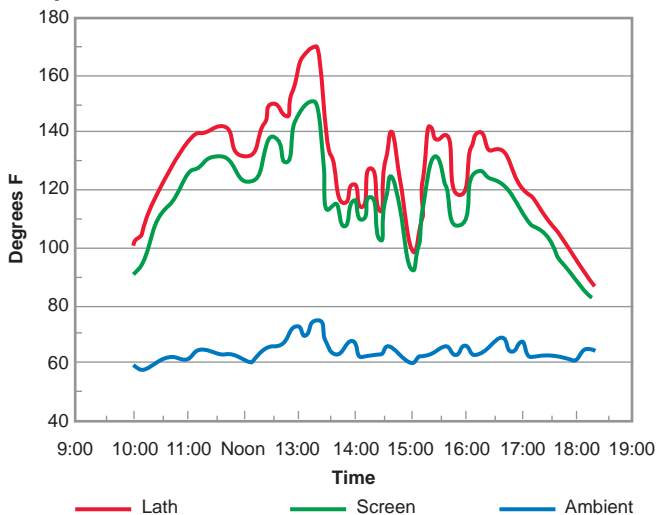

Lath vs. Screen

Next, we compared three layers of pre-painted black aluminum window screening to three layers of galvanized steel lath painted flat black. We found that the lath produced temperatures as much as 15° F (3.6° C) higher than the screen in our outdoor solar food dryer tests. We got the same results when we compared six layers of screen to six layers of lath (see Graph 4). While we found that the lath produced slightly higher temperatures, it was harder to work with, needed to be painted, and cost slightly more than the screen.

When these tests were replicated with the solar simulator, we had slightly better results with the screen than with the lath in both the three and six layer tests. We were disappointed by the lack of positive correlation between our outdoor tests with the actual food dryers and our indoor tests with the solar simulator. But there are many variables to control and quite a few people involved in setting things up and collecting data, so our control was not as tight as we would have liked. Despite these problems, we are confident in concluding that there is not a great deal of difference in performance between lath and screen—both work effectively.

Layers of Absorber Mesh

We then compared three layers of lath to six layers of lath, and three layers of screen to six layers of screen. Obviously the more screen used, the greater the expense. The literature on solar air heaters recommends between five and seven layers. We arbitrarily picked three and six layers. In our outdoor tests, we found that six layers of screen produced temperatures 5–10° F (1.2–2.4° C) higher than three layers. Likewise, when we repeated these experiments outdoors with lath, we found that six layers outperformed both two and four layers (see Graph 5).

Graph 5: Two vs. Four vs. Six Layers of Absorber

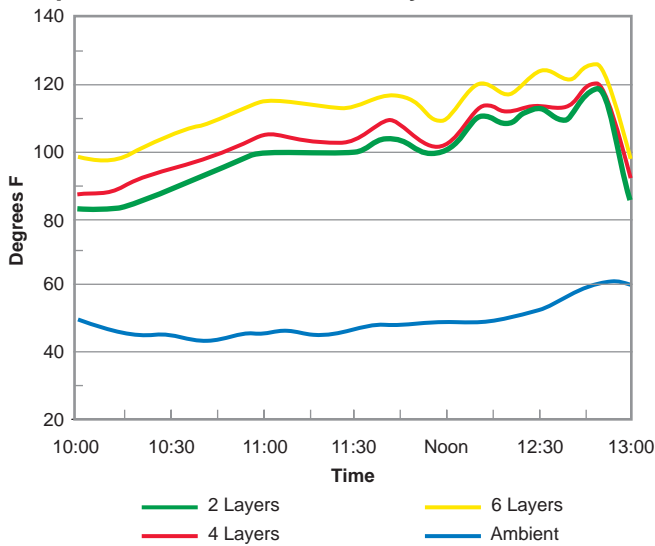

Graph 7: Absorber Installation Comparison

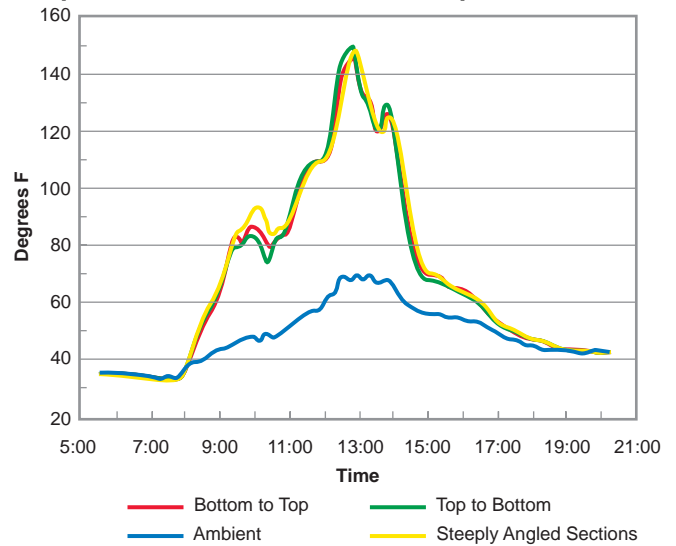

Tests performed in the solar simulator showed very little difference between three and six layers. We used the simulator to test one and two layers and no absorber. With no absorber, the temperature decline was over 60° F (33° C), dropping from 153 to 89° F (67 to 32° C). The temperatures for one, two, three, and six layers of lath after one half-hour were 145, 155, 159, and 160° F (63, 68, 70, and 71° C). Based on our work, we feel that two or three layers of screen or lath are adequate for effective performance, but adding a few more layers will produce slightly higher temperatures.

Reflective Is Effective

When constructing a solar air heater, you must decide what to do with the bottom of the air flow channel, below the absorbing material. In the next part of our research, we placed aluminum flashing in the bottom of the air flow channels of two of the three dryers, on top

Graph 6: Collector Bottom Material Comparison

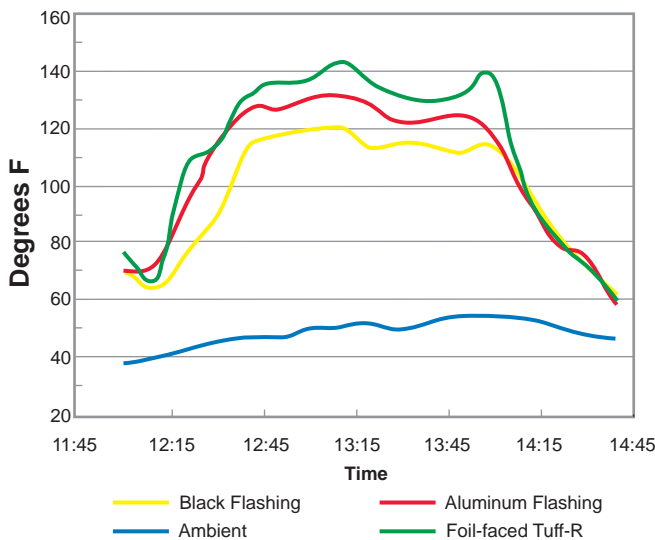

of the 3/4 inch (19 mm) foil-faced insulation (Celotex Tuff-R, polyisocyanurate). The flashing in one of the dryers was painted flat black. The third dryer was left with just the reflective insulation board on the bottom of the air flow channel. This test was done with both the actual dryers and the solar simulator. In both cases, the highest temperatures were attained with the reflective foil-faced insulation. The differences were substantial, with the reflective insulation showing readings as much as 25° F (14° C) higher than the dryer with the black aluminum flashing (see Graph 6).

Mesh Installation

The original design called for the mesh to be inserted into the collector diagonally from the bottom of the air flow channel to the top (see Figure 7). This seemed the best from a construction point of view. In this test, three configurations were compared: from bottom to top as originally designed, from top to bottom, and a series of more steeply angled pieces of mesh stretching from the top to the bottom of the air flow channel. The differences in temperatures attained were very small (see Graph 7), and we concluded that there was not much difference in performance.

U-Tube vs. Single Pass

Another characteristic of the original design is the U-tube air flow channel. In addition to the air flow channel right below the glazing, there is a second air flow channel right below the first one, separated by a piece of insulation board (see Figure 7). We compared a dryer with this U-tube design to a dryer with just a straight shot single channel and found no significance difference in temperatures. We removed the insulation board from our dryers and have completed all the experiments detailed in this article without the U-tube setup.

Graph 8: PV Exhaust Fan vs. Vent

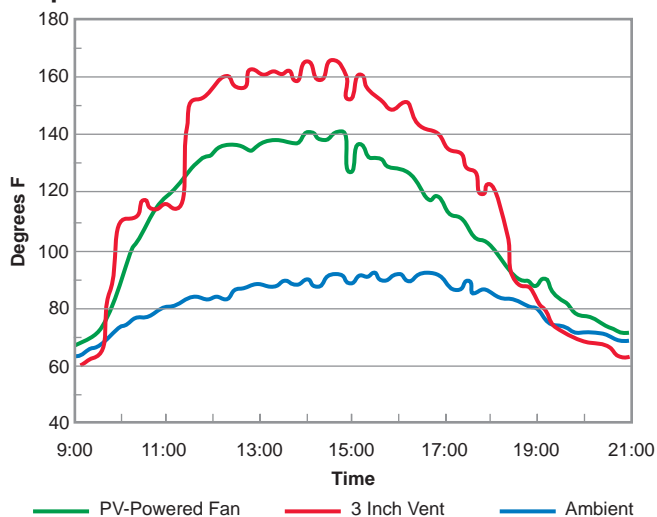

Active vs. Passive

We experimented with several small, PV-powered fans to see if they would generate higher air flows and possibly accelerate food dehydration. We tried three different sizes: 0.08, 0.15, and 0.46 amps. We placed the fans in the exhaust area of the dryer. Of the three, the 0.15 amp fan seemed to work the best. It increased the air flow from about 25 to 50 feet per minute (8 to 15 meters per minute), but decreased temperatures significantly (see Graph 8). The larger fan did not fit in the exhaust vent opening, and the smallest fan did not significantly increase the air flow.

Even with the fans in use, the drying performance did not improve. In every trial, the passive dryer either matched or outperformed the active dryer. Each morning during a five-day experiment, we placed exactly the same weight of fruit in each dryer. We used one to three pounds (0.4 to 1.4 kg) of apple or peach slices. Each afternoon between 2:30 and 5 PM, we

Graph 9: Three Inch vs. Six Inch Exhaust Vent

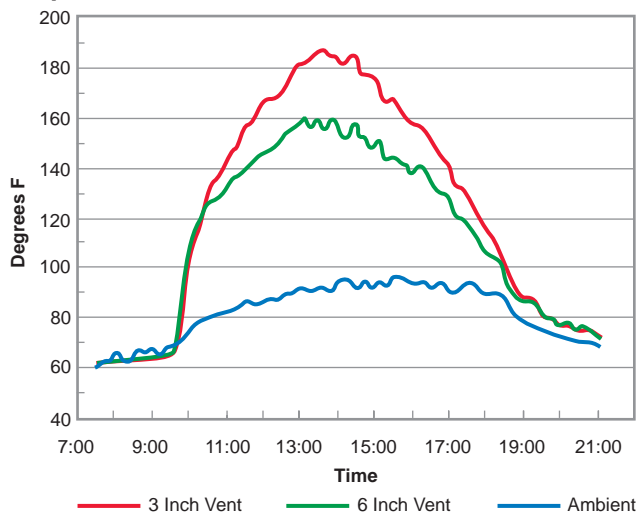

removed and weighed the fruit. On all five days, the fruit dried in the passive dryer weighed either the same or less than the fruit dried in the active dryer.

Vent Opening

The dryers have vent covers at the top which can be adjusted to regulate the air flow and temperature. The smaller the opening, the higher the temperatures attained. We wanted to know how much the vents should be opened for maximum drying effectiveness. We tried a variety of venting combinations while drying fruit. For most of our experiments, we filled five to seven of the thirteen shelves with 1/8 inch (3 mm) fruit slices. We cut up, weighed, and placed an identical quantity and quality of fruit in each of two dryers in the morning. Sometime between 2 and 6 PM, we removed the fruit from the dryers and weighed it again. We compared openings of different measurements: a one inch (25 mm) to a seven inch (178 mm), a 3/4 inch (19 mm) to a five inch (127 mm), a three inch (76 mm) to a six inch (152 mm), a three inch (76 mm) to a nine inch (229 mm), and a three inch (76 mm) to a five inch (127 mm). During these experiments, the bottom vents were completely open.

We found that higher temperatures were attained with smaller vent openings, but that drying effectiveness was not always maximized. The best performance was observed when the vents were opened between three and six inches (76 and 152 mm), and temperatures peaked at 135–180 °F (54–82° C) (see Graph 9). With the one inch (25 mm) and smaller openings and the seven inch (178 mm) and larger openings, less water was removed from the fruit. There was no difference in the water removed when we compared three inches to five inches (76 mm to 127 mm) and three inches to six inches (76 mm to 152 mm).

Based on this work, we would recommend opening the leeward exhaust vent cover between three and six inches (76 and 152 mm), or between ten and twenty square inches (65 and 129 cm²) of total exhaust area. The exact size of the opening depends on the weather conditions. With the vents opened between three and six inches (76 and 152 mm), we have been able to remove as much as sixty ounces (1.75 l) of water in a single day from a full load of fruit and completely dry about three and one-half pounds (1.5 kg) of apple slices to 12–15% of the fruit's wet weight.

Construction Improvements

As we experimented with the dryers, we came up with some design improvements to simplify the construction, reduce the cost, and increase the durability or portability of the unit. To simplify the construction and eliminate warping problems caused by wet weather, we decided to eliminate the intake vent covers during our

experiments. The vent covers at the top, if closed at night, would prevent or reduce reverse thermosiphoning and rehydration of food left in the dryer.

The redesigned air intake now has aluminum screen secured to the plywood side pieces with wooden trim. We also redesigned the top exhaust vent cover to eliminate the warping problem caused by leaving the vent covers opened during wet weather. The new exhaust vent cover works very well (see Photo 6). It spreads the exhaust air across the dryer's width rather than concentrating it in the center. This should improve convective flows and performance. However, the vent cover makes it more difficult to calculate the exhaust area, and as a result, we mainly used the old design for our research this past year.

We added wheels and handles to the unit, as it is heavy and difficult to move around. It's now easier to maneuver, although it is still difficult to transport in a small pickup truck. We purchased ten-inch (254 mm) lawnmower-style wheels for \$6 each. The axle cost \$2. With the wheels on the small legs at the bottom of the collector, one person can move the dryer.

The original design specified thin plywood for the roof of the dryer. We replaced that with 3/4 inch (19 mm) plywood and covered the peak of the roof with aluminum flashing. We also used 1/2 inch (38 mm) wide by 1/8 inch (3 mm) thick aluminum bar stock and stainless steel screws to attach the glazing to the dryer's collector. Each collector used fourteen feet, eight inches (4.5 m) of aluminum bar at a cost of \$23. The 1/4 inch (6 mm) plywood strips used in the original design were adequate and less expensive, but would have required more maintenance.

Conclusions and Recommendations

The dryer described in *HP57* has worked well in our tests. It produces temperatures of 130–180° F (54–82° C), and can dry up to 15 apples or peaches—about 3 1/2 pounds (1.6 kg) of 1/8 inch (3 mm) thick slices—in one sunny to partly sunny day. The best performance in our outdoor tests was attained with six layers of expanded steel lath painted black, although aluminum screen works almost as well and is easier to work with. We also found that two or three layers of screen or lath would produce temperatures almost as high as six layers. The surface behind the absorber mesh should be reflective, and for best performance the exhaust vent covers should be opened three to six inches (76–152 mm). The cost of the dryer and the time to construct it can be reduced by eliminating the U-tube air flow channel divider, the second or inner layer of glazing, and the intake vent covers, and by reducing the number of layers of screen or lath to two or three.



Above, Photo 6: The new vent design.

We made the unit more portable by adding wheels and handles, and improved the durability by fastening the legs with nuts and bolts, using aluminum bar to hold the glazing in place, and using 3/4 inch (19 mm) plywood for the roof. We would also like to take the insulation board out of a dryer to see if it significantly impacts the performance. This would further decrease the cost of the dryer. Soon, we hope to compare this design to direct solar dryers, which a *Home Power* reader has recently suggested can outperform our design. Thus far, we have avoided direct dryers because of concerns about vitamin loss in foods exposed to direct solar radiation.

We have tried to carefully explore all of the significant variables affecting this dryer's performance. We have been able to increase drying effectiveness with higher temperatures of approximately 30° F (16.6° C), while decreasing the cost by about \$30. We have demonstrated the best vent opening for drying effectiveness, and seen the impact that variables such as double glazing, fans, reflectors, and absorber type have on performance. We have also developed and demonstrated a low cost solar simulator that can be used to test solar thermal collectors indoors.

Access

Authors: Dennis Scanlin, Marcus Renner, David Domermuth, and Heath Moody, Department of Technology, Appalachian State University, Boone, NC 28608 • 704-262-3111 • scanlindm@appstate.edu

Solar Dehydration

Solar Cookers International (SCI), 1919 21st Street,
Sacramento, CA 95814 • 916-455-4499
Fax: 916-455-4498 • sci@igc.org

Sun-Lite HP glazing was purchased from Solar
Components Corporation, 121 Valley Street,
Manchester, NH 03103-6211 • 603-668-8186
Fax: 603-668-1783 • solar2@ix.netcom.com
www.solar-components.com

Scales, anemometers, and other data collection
equipment were purchased from Thomas Scientific,
PO Box 99, Swedesboro, NJ 08085 • 800-345-2100
609-467-2000 • Fax: 800-345-5232
value@thomassci.com • www.thomassci.com

Data logger was purchased from Pace Scientific, Inc.,
6407 Idlewild Rd., Suite 2.214, Charlotte, NC 28212
704-568-3691 • Fax: 704-568-0278
sales@pace-sci.com • www.pace-sci.com

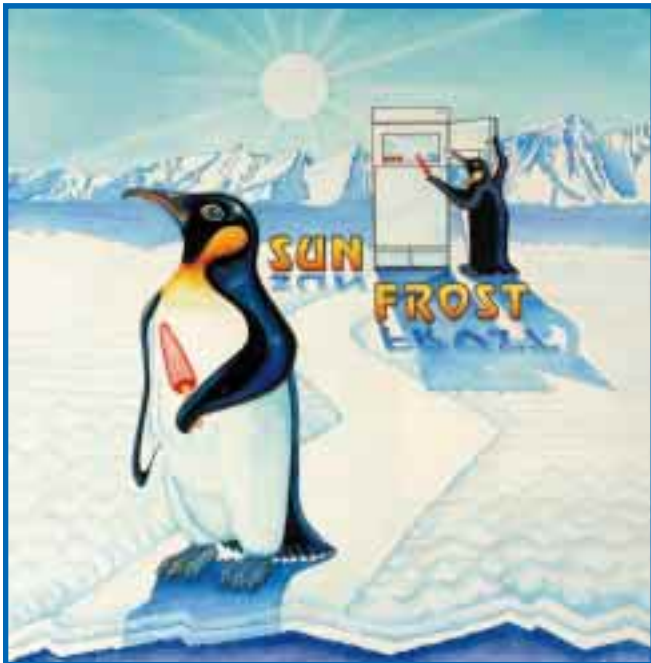

Fight Global Warming SUN FROST

P.O. Box 1101, Arcata, CA 95518-1101
Phone: 707-822-9095 • Fax: 707-822-6213 • www.sunfrost.com

Creating Peace of Mind!



Peace of mind has become a premium in today's society. The Y2K problem has created unrest, fear and even panic in the minds of millions of Americans. The global economy is going berserk. But while the future is definitely uncertain, one thing you can count on is the fact that no matter what happens, you will need food and water! Emergency food storage is a wise safeguard against all emergencies from floods, earthquakes and hurricanes to unemployment or illness.

Millennium III Foods offers nutritionally balanced food plans for individuals, families or communities at competitive prices.

At Millennium III Foods, we don't just sell storage food...

WE CREATE PEACE OF MIND.

- TWO WEEK SHIPPING
- "One Year Supplies" are nutritionally balanced to deliver over 1,900 calories per day
- Real food that's easy to use!
- Awarded #1 Best Tasting
- A La Carte ordering or purchase One Year Units for one, two or four persons. Great value, simple planning!

Call for prices and information

SALES 888-883-1603

FAX 406-388-2603

P.O. Box 10010
Bozeman, Montana 59719
WWW.M3MFOODS.COM