



*Every Boy's  
Mechanical  
Library*



**AEROPLANES**

# EVERY BOY'S MECHANICAL LIBRARY

By J. S. ZERBE, M.E.

Price, per volume, 60 cents, Net. Postage extra.

---

## AUTOMOBILES

This is a subject in which every boy is interested. While few mechanics have the opportunity to actually build an automobile, it is the knowledge which he must acquire about every particular device used, that enables him to repair and put such machines in order. The aim of this book is to make the boy acquainted with each element, so that he may understand why it is made in that special way, and what the advantages and disadvantages are of the different types. To that end each structure is shown in detail as much as possible, and the parts separated so as to give a clear insight of the different functions, all of which are explained by original drawings specially prepared to aid the reader.

## MOTORS

To the boy who wants to know the theory and the practical working of the different kinds of motors, told in language which he can understand, and illustrated with clear and explicit drawings, this volume will be appreciated. It sets forth the groundwork on which power is based, and includes steam generators, and engines, as well as wind and water motors, and thoroughly describes the Internal Combustion Engine. It has special chapters on Carbureters, Ignition, and Electrical systems used, and particularly points out the parts and fittings required with all devices needed in engine. It explains the value of compounding, condensing, pre-heating and expansion, together with the methods used to calculate and transmit power. Numerous original illustrations.

## AEROPLANES

This work is not intended to set forth the exploits of aviators nor to give a history of the Art. It is a book of instructions intended to point out the theories of flying, as given by the pioneers, the practical application of power to the various flying structures; how they are built; the different methods of controlling them; the advantages and disadvantages of the types now in use; and suggestions as to the directions in which improvements are required. It distinctly points out wherein mechanical flight differs from bird flight, and what are the relations of shape, form, size and weight. It treats of kites, gliders and model aeroplanes, and has an interesting chapter on the aeroplane and its uses in the great war. All the illustrations have been specially prepared for the work.

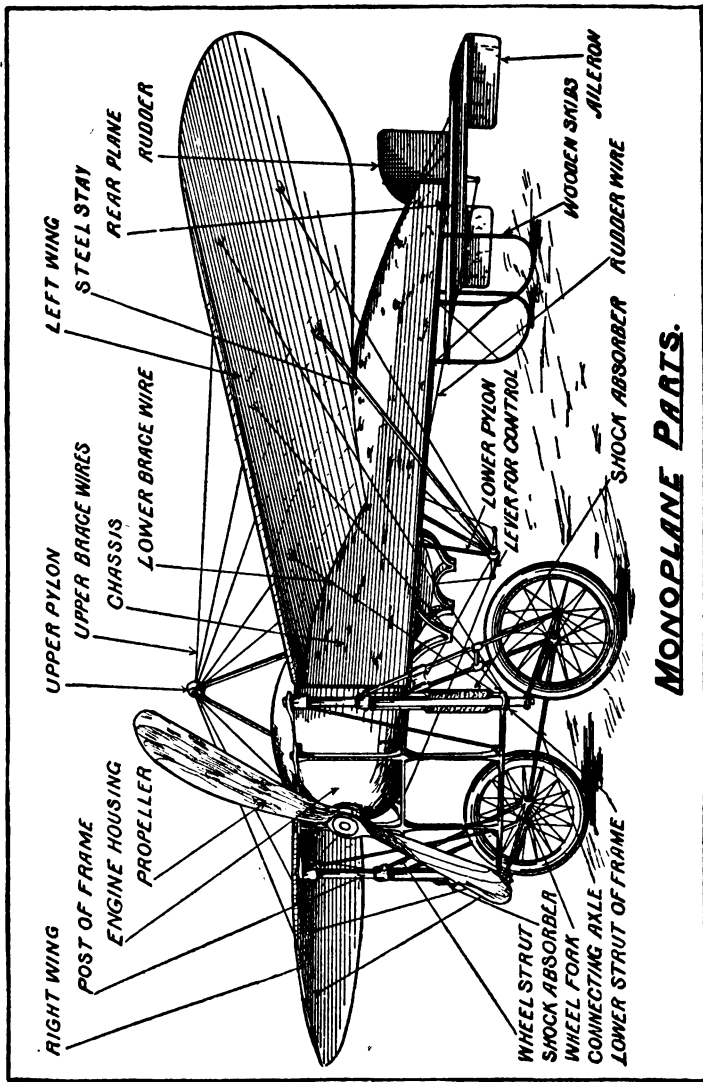
---

CUPPLES & LEON CO., Publishers,

NEW YORK

**THE NEW YORK  
PUBLIC LIBRARY**

**ASTOR, LENOX  
TILDEN FOUNDATIONS**



**MONOPLANE PARTS.**

Every Boy's Mechanical Library

# AEROPLANES

BY  
J. S. ZERBE, M.E.  
Author of  
*Automobiles—Motors*

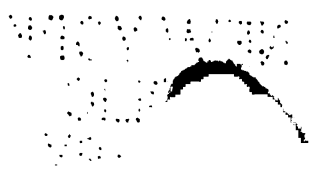
**ILLUSTRATED**

NEW YORK  
CUPPLES & LEON COMPANY

1915

THE  
PUBLIC  
70054A  
ASTOR. L.  
ILDEN FOUND  
R

COPYRIGHT, 1915, BY  
CUPPLES & LEON COMPANY



# CONTENTS

	PAGE
INTRODUCTORY . . . . .	1-3
CHAPTER I. THEORIES AND FACTS ABOUT FLYING . . . . .	5-32

The "Science" of Aviation. Machine Types. Shape or Form not Essential. A Stone as a Flying Machine. Power the Great Element. Gravity as Power. Mass and Element in Flying. Momentum a Factor. Resistance. How Resistance Affects Shape. Mass and Resistance. The Early Tendency to Eliminate Momentum. Light Machines Unstable. The Application of Power. The Supporting Surfaces. Area not the Essential Thing. The Law of Gravity. Gravity. Indestructibility of Gravitation. Distance Reduces Gravitational Pull. How Motion Antagonizes Gravity. A Tangent. Tangential Motion Represents Centrifugal Pull. Equalizing the Two Motions. Lift and Drift. Normal Pressure. Head Resistance. Measuring Lift and Drift. Pressure at Different Angles. Difference Between Lift and Drift in Motion. Tables of Lift and Drift. Why Tables of Lift and Drift are Wrong. Langley's Law. Moving Planes vs. Winds. Momentum not Considered. The Flight of Birds. The Downward Beat. The Concaved Wing. Feather Structure Considered. Webbed Wings. The Angle of Movement. An Initial Movement or Impulse Necessary. A Wedging Motion. No Mystery in the Wave Motion. How Birds Poise with Flapping Wings. Narrow-winged Birds. Initial Movement of Soaring Birds. Soaring Birds Move Swiftly. Muscular Energy Exerted by Soaring Birds. Wings not Motionless.

CHAPTER II. PRINCIPLES OF AEROPLANE FLIGHT . . . . .	33-39
--	-------

Speed as one of the Elements. Shape and Speed. What "Square of the Speed" Means. Action of a "Skipper." Angle of Incidence. Speed and Surface. Control of the Direction of Flight. Vertical Planes.

CHAPTER III. THE FORM OR SHAPE OF FLYING MACHINES . . . . .	40-49
---	-------

The Theory of Copying Nature. Hulls of Vessels. Man Does not Copy Nature. Principles Essential, not Forms. Nature not the Guide as to Forms. The Propeller Type. Why Specially-designed Forms Improve

22X263



# CONTENTS

PAGE

Natural Structures. Mechanism Devoid of Intelligence. A Machine Must Have a Substitute for Intelligence. Study of Bird Flight Useless. Shape of Supporting Surface. The Trouble Arising From Outstretched Wings. Density of the Atmosphere. Elasticity of the Air. "Air Holes." Responsibility for Accidents. The Turning Movement. Centrifugal Action. The Warping Planes.

## CHAPTER IV. FORE AND AFT CONTROL . . . . . 50-64

The Bird Type of Fore and Aft Control. Angle and Direction of Flight. Why Should the Angle of the Body Change. Changing Angle of Body not Safe. A Non-changing Body. Descending Positions by Power Control. Cutting off the Power. The Starting Movement. The Suggested Type. The Low Center of Gravity. Fore and Aft Oscillations. Application of the New Principle. Low Weight not Necessary with Synchronously-moving Wings.

## CHAPTER V. DIFFERENT MACHINE TYPES AND THEIR CHARACTERISTICS . . . . . 65-73

The Helicopter. Aeroplanes. The Monoplane. Its Advantages. Its Disadvantages. The Bi-plane. Stability in Bi-planes. The Orthopter. Nature's Type not Uniform. Theories About Flight of Birds. Instinct. The Mode of Motion. The Wing Structure. The Wing Movement. The Helicopter Motion.

## CHAPTER VI. THE LIFTING SURFACES OF AEROPLANES . 74-84

Relative Speed and Angle. Narrow Planes Most Effective. Stream Lines Along a Plane. The Center of Pressure. Air Lines on the Upper Side of a Plane. Rarefied Area. Rarefaction Produced by Motion. The Concaved Plane. The Center of Pressure. Utilizing the Rarefied Area. Changing Center of Pressure. Plane Monstrosities. The Bird Wing Structure. Torsion. The Bat's Wing. An Abnormal Shape. The Tail as a Monitor.

## CHAPTER VII. ABNORMAL FLYING STUNTS AND SPEEDS . 85-93

Lack of Improvements in Machines. Men Exploited and not Machines. Abnormal Flying of no Value. The Art of Juggling. Practical Uses the Best Test. Concaved and Convex Planes. How Momentum is a Factor in Inverted Flying. The Turning Movement. When Concaved Planes are Desirable. The Speed Mania. Uses of Flying Machines. Perfection in Machines Must Come Before Speed. The Range of its Uses. Commercial Utility.

# CONTENTS

	PAGE
<b>CHAPTER VIII. KITES AND GLIDERS . . . . .</b>	<b>94-112</b>
The Dragon Kite. Its Construction. The Malay Kite. Dihedral Angle. The Common Kite. The Bow Kite. The Box Kite. The Voison Bi-plane. Lateral Stability in Kites, not Conclusive as to Planes. The Spear Kite. The Cellular Kite. Tetrahedral Kite. The Deltoid. The Dunne Flying Machine. Rotating Kite. Kite Principles. Lateral Stability in Kites. Similarity of Fore and Aft Control. Gliding Flight. One of the Uses of Glider Experiments. Hints in Gliding.	
<b>CHAPTER IX. AEROPLANE CONSTRUCTION . . . . .</b>	<b>113-130</b>
Lateral and Fore and Aft. Transverse. Stability and Stabilization. The Wright System. Controlling the Warping Ends. The Curtiss Wings. The Farman Ailerons. Features Well Developed. Depressing the Rear End. Determining the Size. Rule for Placing the Planes. Elevating Plane. Action in Alighting. The Monoplane. The Common Fly. Stream Lines. The Monoplane Form.	
<b>CHAPTER X. POWER AND ITS APPLICATION . . . . .</b>	<b>131-142</b>
Features in Power Application. Amount of Power Necessary. The Pull of the Propeller. Foot Pounds. Small Amount of Power Available. High Propeller Speed Important. Width and Pitch of Blades. Effect of Increasing Propeller Pull. Disposition of the Planes. Different Speeds with Same Power. Increase of Speed Adds to Resistance. How Power Decreases with Speed. How to Calculate the Power Applied. Pulling Against an Angle. The Horizontal and the Vertical Pull. The Power Mounting. Securing the Propeller to the Shaft. Vibrations. Weaknesses in Mounting. The Gasoline Tank. Where to Locate the Tank. The Danger to the Pilot. The Closed-in Body. Starting the Machine. Propellers with Varying Pitch.	
<b>CHAPTER XI. FLYING MACHINE ACCESSORIES . . . . .</b>	<b>143-166</b>
The Anemometer. The Anemograph. The Anemometrograph. The Speed Indicator. Air Pressure Indicator. Determining the Pressure From the Speed. Calculating Pressure From Speed. How the Figures are Determined. Converting Hours Into Minutes. Changing Speed Hours to Seconds. Pressure as the Square of the Speed. Gyroscopic Balance. The Principles Involved. The Application of the Gyroscope. Fore and Aft Gyroscopic Control. Angle Indicator. Pendulum Stabilizer. Steering and Controlling	

# CONTENTS

PAGE

Wheel. Automatic Stabilizing Wings. Barometers. Aneroid Barometer. Hydroplanes. Sustaining Weight of Pontoons. Shape of the Pontoon.

## CHAPTER XII. EXPERIMENTAL WORK IN FLYING . . . 167-185

Certain Conditions in Flying. Heat in Air. Motion When in Flight. Changing Atmosphere. "Ascending Currents." "Aspirate Currents." Outstretched Wings. The Starting Point. The Vital Part of the Machine. Studying the Action of the Machine. Elevating the Machine. How to Practice. The First Stage. Patience the Most Difficult Thing. The Second Stage. The Third Stage. Observations While in Flight. Flying in a Wind. First Trials in a Quiet Atmosphere. Making Turns. The Fourth Stage. The Figure 8. The Vol Plane. The Landing. Flying Altitudes.

## CHAPTER XIII. THE PROPELLER . . . . . 186-195

Propeller Changes. Propeller Shape. The Diameter. Pitch. Laying Out the Pitch. Pitch Rule. Laminated Construction. Laying up a Propeller Form. Making Wide Blades. Propeller Outline. For High Speeds. Increasing Propeller Efficiency.

## CHAPTER XIV. EXPERIMENTAL GLIDERS AND MODEL AEROPLANES . . . . . 196-205

The Relation of Models to Flying Machines. Lessons From Models. Flying Model Aeroplanes. An Efficient Glider. The Deltoid Formation. Racing Models. The Power for Model Aeroplanes. Making the Propeller. Material for the Propeller. Rubber. Propeller Shape and Size. Supporting Surfaces.

## CHAPTER XV. THE AEROPLANE IN THE GREAT WAR . . . 206-222

Balloon Observations. Changed Conditions in Warfare. The Effort to Conceal Combatants. Smokeless Powder. Inventions to Attack Aerial Craft. Functions of the Aeroplane in War. Bomb-throwing Tests. Method for Determining the Movement of a Bomb. The Great Extent of Modern Battle Lines. The Aeroplane Detecting the Movements of Armies. The Effective Height for Scouting. Sizes of Objects at Great Distances. Some Daring Feats in War. The German Taube. How Aeroplanes Report Observations. Signal Flags. How Used. Casualties Due to Bombs From Aeroplanes.

## GLOSSARY . . . . . 223-242

## LIST OF ILLUSTRATIONS

FIG.	PAGE
1. Tangential flight .....	16
2. Horizontal flight .....	18
3. Lift and drift .....	19
4. Normal air pressure .....	20
5. Edge resistance .....	20
6. Measuring lift and drift .....	21
7. Equal lift and drift in flight .....	25
8. Unequal lift and drift .....	25
9. Wing movement in flight .....	29
10. Evolution of humming-bird's wing .....	30
11. A skipper in flight .....	35
11a. Monoplane in flight .....	52
12. Angles of flight .....	53
13. Planes on non-changing body .....	55
14. Descent with non-changing body .....	56
15. Utilizing momentum .....	57
16. Reversing motion .....	58
17. Showing changing angle of body .....	59
18. Showing non-changing angle of frame .....	60
19. Normal flight, with propeller pulling .....	61
20. Action when propeller ceases to pull .....	62
21. Synchronously-moving planes .....	63
22. Stream lines along a plane .....	75
23. Air lines on the upper side of a plane .....	78
24. Air lines below a concaved plane .....	79
25. Air lines above a convex plane .....	80
26. Changing centers of pressures .....	81
27. Changing centers of pressures .....	81
28. Bird-wing structures .....	81
29. Bird-wing structures .....	81

## LIST OF ILLUSTRATIONS

FIG.		PAGE
30.	One of the monstrosities .....	83
31.	Flying upside down .....	89
32.	Chart showing range of uses .....	92
33.	Ribs of dragon kite .....	95
34.	The Malay kite .....	96
35.	Dihedral angle .....	96
36.	Common kite .....	97
37.	Bow kite .....	98
38.	Sexagonal kite .....	98
39.	Hargreave kite .....	99
40.	Voison biplane .....	100
41.	Spear kite .....	101
42.	Cellular kite .....	101
43.	Tetrahedral kite .....	102
44.	Deltoid formation .....	103
45.	Deltoid formation .....	103
46.	The Dunne bi-plane .....	104
47.	Rotable umbrella kite .....	105
48.	Action of wind forces on kite .....	107
49.	Farman ailerons .....	115
49a.	Rule for spacing planes .....	119
50.	Frame of control planes .....	119
51.	Side elevation of frame .....	120
52.	Frame with running gear .....	120
53.	Plan view .....	122
54.	Alighting .....	123
55.	Common fly. Outstretched wings .....	125
56.	Common fly. Folded wings .....	126
57.	Relative size of wing and body .....	126
58.	Plan of monoplane .....	128
59.	Side elevation, monoplane .....	129
60.	Horizontal and vertical pull .....	137
61.	Speed indicator .....	144
62.	Air pressure indicator .....	145
63.	The gyroscope .....	151
64.	Application of the gyroscope .....	152
65.	Action of the gyroscope .....	153
66.	Angle indicator .....	155

## LIST OF ILLUSTRATIONS

FIG.		PAGE
67.	Simple pendulum stabilizer.....	156
68.	Pendulum stabilizers .....	157
69.	Steering and control wheel .....	158
70.	Automatic stabilizing wings .....	159
71.	Action of stabilizing wings .....	159
72.	Into the wind at an angle .....	160
73.	Turning a circle .....	161
74.	Aneroid barometer .....	162
75.	Hydroplane floats .....	165
76.	Describing the pitch line .....	188
77.	Laying out the pitch .....	189
78.	A laminated blank .....	191
79.	Arranging the strips .....	192
80.	End view of blank .....	192
81.	Marking the side .....	193
82.	Outlining .....	193
83.	Cut from a 4" x 6" single blank .....	194
84.	A suggested form .....	195
85.	Deltoid glider .....	199
86.	The Deltoid racer .....	199
87.	"A" shaped racing glider .....	201
88.	Making the propeller.....	203
89.	Shape and size .....	205
90.	Course of a bomb .....	210
91.	Determining altitude and speed .....	211



## INTRODUCTORY

In preparing this volume on Flying Machines the aim has been to present the subject in such a manner as will appeal to boys, or beginners, in this field of human activity.

The art of aviation is in a most primitive state. So many curious theories have been brought out that, while they furnish food for thought, do not, in any way, advance or improve the structure of the machine itself, nor are they of any service in teaching the novice how to fly.

The author considers it of far more importance to teach right principles, and correct reasoning than to furnish complete diagrams of the details of a machine. The former teach the art, whereas the latter merely point out the mechanical arrangements, independently of the reasons for making the structures in that particular way.

Relating the history of an art, while it may be interesting reading, does not even lay the foundations of a knowledge of the subject, hence that field has been left to others.

The boy is naturally inquisitive, and he is interested in knowing *why* certain things are neces-



sary, and the reasons for making structures in particular ways. That is the void into which these pages are placed.


The author knows from practical experience, while experimenting with and building aeroplanes, how eagerly every boy inquires into details. They want the reasons for things.

One such instance is related to evidence this spirit of inquiry. Some boys were discussing the curved plane structure. One of them ventured the opinion that birds' wings were concaved on the lower side. "But," retorted another, "why are birds' wings hollowed?"

This was going back to first principles at one leap. It was not satisfying enough to know that man was copying nature. It was more important to know why nature originated that type of formation, because, it is obvious, that if such structures are universal in the kingdom of flying creatures, there must be some underlying principle which accounted for it.

It is not the aim of the book to teach the art of flying, but rather to show *how* and *why* the present machines fly. The making and the using are separate and independent functions, and of the two the more important is the knowledge how to make a correct machine.

Hundreds of workmen may contribute to the

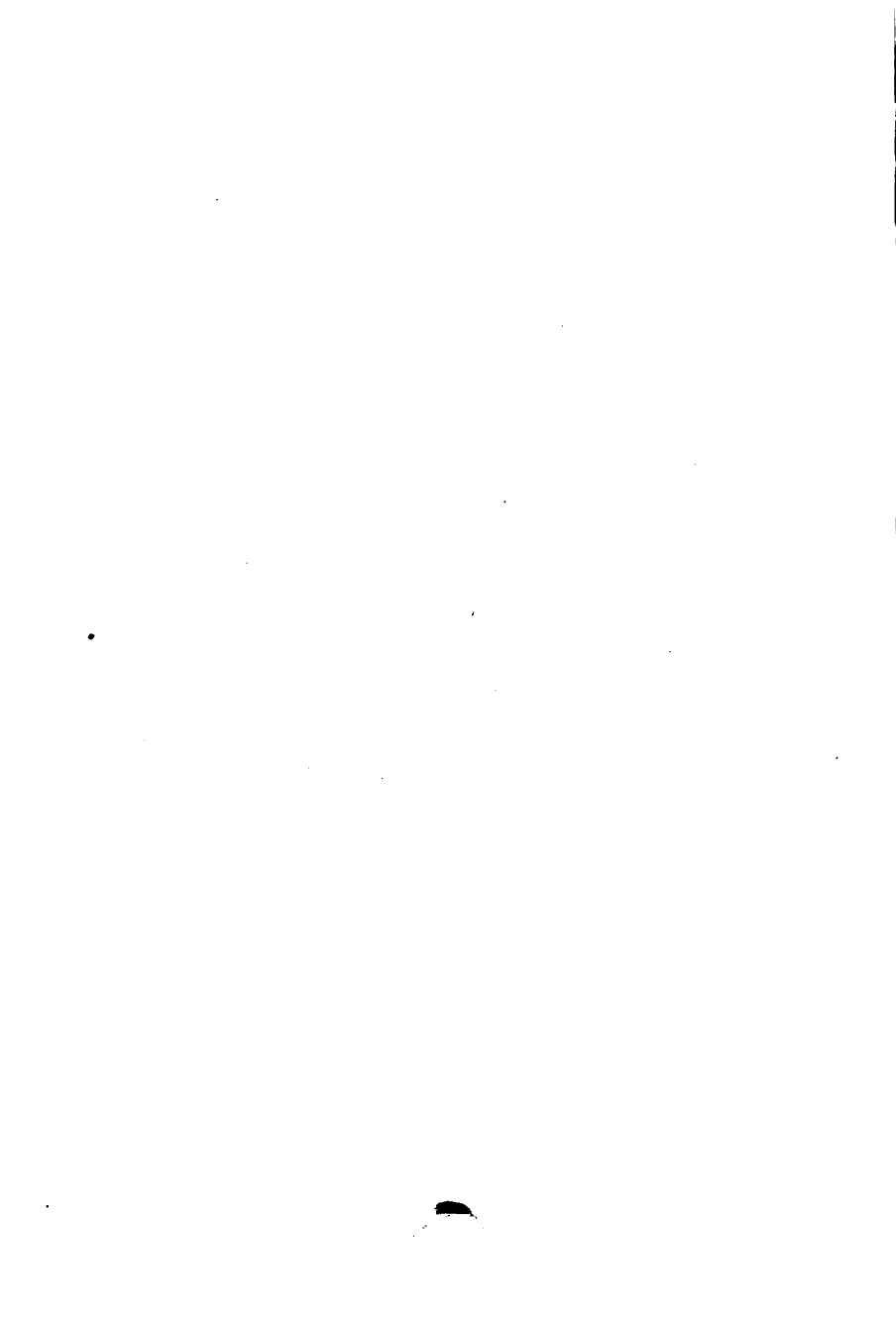


■

building of a locomotive, but one man, not a builder, knows better how to handle it. To manipulate a flying machine is more difficult to navigate than such a ponderous machine, because it requires peculiar talents, and the building is still more important and complicated, and requires the exercise of a kind of skill not necessary in the locomotive.

The art is still very young; so much is done which arises from speculation and theories; too much dependence is placed on the aviator; the desire in the present condition of the art is to exploit the man and not the machine; dare-devil exhibitions seem to be more important than perfecting the mechanism; and such useless attempts as flying upside down, looping the loop, and characteristic displays of that kind, are of no value to the art.

THE AUTHOR.



# AEROPLANES

## CHAPTER I

### THEORIES AND FACTS ABOUT FLYING

THE "SCIENCE" OF AVIATION.—It may be doubted whether there is such a thing as a "science of aviation." Since Langley, on May 6, 1896, flew a motor-propelled tandem monoplane for a minute and an half, without a pilot, and the Wright Brothers in 1903 succeeded in flying a bi-plane with a pilot aboard, the universal opinion has been, that flying machines, to be successful, must follow the structural form of birds, and that shape has everything to do with flying.

We may be able to learn something by carefully examining the different views presented by those interested in the art, and then see how they conform to the facts as brought out by the actual experiments.

MACHINE TYPES.—There is really but one type of plane machine. While technically two forms are known, namely, the monoplane and the bi-

plane, they are both dependent on outstretched wings, longer transversely than fore and aft, so far as the supporting surfaces are concerned, and with the main weight high in the structure, thus, in every particular, conforming to the form pointed out by nature as the apparently correct type of a flying structure.

**SHAPE OR FORM NOT ESSENTIAL.**—It may be stated with perfect confidence, that shape or form has nothing to do with the mere act of flying. It is simply a question of power. This is a broad assertion, and its meaning may be better understood by examining the question of flight in a broad sense.

**A STONE AS A FLYING MACHINE.**—When a stone is propelled through space, shape is of no importance. If it has rough and jagged sides its speed or its distance may be limited, as compared with a perfectly rounded form. It may be made in such a shape as will offer less resistance to the air in flight, but its actual propulsion through space does not depend on how it is made, but on the power which propelled it, and such a missile is a true heavier-than-air machine.

A flying object of this kind may be so constructed that it will go a greater distance, or require less power, or maintain itself in space at less speed; but it is a flying machine, nevertheless,

in the sense that it moves horizontally through the air.

POWER THE GREAT ELEMENT.—Now, let us examine the question of this power which is able to set gravity at naught. The quality called *energy* resides in material itself. It is something within matter, and does not come from without. The power derived from the explosion of a charge of powder comes from within the substance; and so with falling water, or the expansive force of steam.

GRAVITY AS POWER.—Indeed, the very act of the ball gradually moving toward the earth, by the force of gravity, is an illustration of a power within the object itself. Long after Galileo firmly established the law of falling bodies it began to dawn on scientists that *weight* is *force*. After Newton established the law of gravitation the old idea, that power was a property of each body, passed away.

In its stead we now have the firmly established view, that power is something which must have at least two parts, or consist in pairs, or two elements acting together. Thus, a stone poised on a cliff, while it exerts no power which can be utilized, has, nevertheless, what is called *potential* energy. When it is pushed from its lodging place *kinetic* energy is developed. In both cases,

gravity, acting in conjunction with the mass of the stone, produced power.

So in the case of gunpowder. It is the unity of two or more substances, that causes the expansion called power. The heat of the fuel converting water into steam, is another illustration of the unity of two or more elements, which are necessary to produce *energy*.

MASS AN ELEMENT IN FLYING.—The boy who reads this will smile, as he tells us that the power which propelled the ball through the air came from the thrower and not from the ball itself. Let us examine this claim, which came from a real boy, and is another illustration how acute his mind is on subjects of this character.

We have two balls the same diameter, one of iron weighing a half pound, and the other of cotton weighing a half ounce. The weight of one is, therefore, sixteen times greater than the other.

Suppose these two balls are thrown with the expenditure of the same power. What will be the result? The iron ball will go much farther, or, if projected against a wall will strike a harder blow than the cotton ball.

MOMENTUM A FACTOR.—Each had transferred to it a motion. The initial speed was the same, and the power set up equal in the two. Why this difference? The answer is, that it is in the ma-

terial itself. It was the mass or density which accounted for the difference. It was mass multiplied by speed which gave it the power, called, in this case, *momentum*.

The iron ball weighing eight ounces, multiplied by the assumed speed of 50 feet per second, equals 400 units of work. The cotton ball, weighing  $\frac{1}{2}$  ounce, with the same initial speed, represents 25 units of work. The term "unit of work" means a measurement, or a factor which may be used to measure force.

It will thus be seen that it was not the thrower which gave the power, but the article itself. A feather ball thrown under the same conditions, would produce a half unit of work, and the iron ball, therefore, produced 800 times more energy.

RESISTANCE.—Now, in the movement of any body through space, it meets with an enemy at every step, and that is air *resistance*. This is much more effective against the cotton than the iron ball: or, it might be expressed in another way: The momentum, or the power, residing in the metal ball, is so much greater than that within the cotton ball that it travels farther, or strikes a more effective blow on impact with the wall.

HOW RESISTANCE AFFECTS THE SHAPE.—It is because of this counterforce, resistance, that shape becomes important in a flying object. The metal



ball may be flattened out into a thin disk, and now, when the same force is applied, to project it forwardly, it will go as much farther as the difference in the air impact against the two forms.

**MASS AND RESISTANCE.**—Owing to the fact that resistance acts with such a retarding force on an object of small mass, and it is difficult to set up a rapid motion in an object of great density, lightness in flying machine structures has been considered, in the past, the principal thing necessary.

**THE EARLY TENDENCY TO ELIMINATE MOMENTUM.**—Builders of flying machines, for several years, sought to eliminate the very thing which gives energy to a horizontally-movable body, namely, momentum.

Instead of momentum, something had to be substituted. This was found in so arranging the machine that its weight, or a portion of it, would be sustained in space by the very element which seeks to retard its flight, namely, the atmosphere.

If there should be no material substance, like air, then the only way in which a heavier-than-air machine could ever fly, would be by propelling it through space, like the ball was thrown, or by some sort of impulse or reaction mechanism on the air-ship itself. It could get no support from the atmosphere.



**LIGHT MACHINES UNSTABLE.**—Gradually the question of weight is solving itself. Aviators are beginning to realize that momentum is a wonderful property, and a most important element in flying. The safest machines are those which have weight. The light, willowy machines are subject to every caprice of the wind. They are notoriously unstable in flight, and are dangerous even in the hands of experts.

**THE APPLICATION OF POWER.**—The thing now to consider is not form, or shape, or the distribution of the supporting surfaces, but *how* to apply the power so that it will rapidly transfer a machine at rest to one in motion, and thereby get the proper support on the atmosphere to hold it in flight.

**THE SUPPORTING SURFACES.**—This brings us to the consideration of one of the first great problems in flying machines, namely, the supporting surfaces,—not its form, shape or arrangement, (which will be taken up in their proper places), but the area, the dimensions, and the angle necessary for flight.

**AREA NOT THE ESSENTIAL THING.**—The history of flying machines, short as it is, furnishes many examples of one striking fact: That area has but little to do with sustaining an aeroplane when once in flight. The first Wright flyer weighed

741 pounds, had about 400 square feet of plane surface, and was maintained in the air with a 12 horse power engine.

True, that machine was shot into the air by a catapult. Motion having once been imparted to it, the only thing necessary for the motor was to maintain the speed.

There are many instances to show that when once in flight, one horse power will sustain over 100 pounds, and each square foot of supporting surface will maintain 90 pounds in flight.

THE LAW OF GRAVITY.—As the effort to fly may be considered in the light of a struggle to avoid the laws of nature with respect to matter, it may be well to consider this great force as a fitting prelude to the study of our subject.

Proper understanding, and use of terms is very desirable, so that we must not confuse them. Thus, *weight* and *mass* are not the same. Weight varies with the latitude, and it is different at various altitudes; but mass is always the same.

If projected through space, a certain mass would move so as to produce momentum, which would be equal at all places on the earth's surface, or at any altitude.

*Gravity* has been called weight, and *weight* gravity. The real difference is plain if gravity is considered as the attraction of mass for mass.

Gravity is generally known and considered as a force which seeks to draw things to the earth. This is too narrow.

Gravity acts in all directions. Two balls suspended from strings and hung in close proximity to each other will mutually attract each other. If one has double the mass it will have twice the attractive power. If one is doubled and the other tripled, the attraction would be increased six times. But if the distance should be doubled the attraction would be reduced to one-fourth; and if the distance should be tripled then the pull would be only one-ninth.

The foregoing is the substance of the law, namely, that all bodies attract all other bodies with a force directly in proportion to their mass, and inversely as the square of their distance from one another.

To explain this we cite the following illustration: Two bodies, each having a mass of 4 pounds, and one inch apart, are attracted toward each other, so they touch. If one has twice the mass of the other, the smaller will draw the larger only one-quarter of an inch, and the large one will draw the other three-quarters of an inch, thus confirming the law that two bodies will attract each other in proportion to their mass.

Suppose, now, that these balls are placed two

inches apart,—that is, twice the distance. As each is, we shall say, four pounds in weight, the square of each would be 16. This does not mean that there would be sixteen times the attraction, but, as the law says, *inversely* as the square of the distance, so that at two inches there is only one-sixteenth the attraction as at one inch.

If the cord of one of the balls should be cut, it would fall to the earth, for the reason that the attractive force of the great mass of the earth is so much greater than the force of attraction in its companion ball.

INDESTRUCTIBILITY OF GRAVITATION.—Gravity cannot be produced or destroyed. It acts between all parts of bodies equally; the force being proportioned to their mass. It is not affected by any intervening substance; and is transmitted instantaneously, whatever the distance may be.

While, therefore, it is impossible to divest matter of this property, there are two conditions which neutralize its effect. The first of these is position. Let us take two balls, one solid and the other hollow, but of the same mass, or density. If the cavity of the one is large enough to receive the other, it is obvious that while gravity is still present the lines of attraction being equal at all points, and radially, there can be no pull which moves them together.

DISTANCE REDUCES GRAVITATIONAL PULL.—Or the balls may be such distance apart that the attractive force ceases. At the center of the earth an object would not weigh anything. A pound of iron and an ounce of wood, one sixteen times the mass of the other, would be the same,—absolutely without weight.

If the object should be far away in space it would not be influenced by the earth's gravity; so it will be understood that position plays an important part in the attraction of mass for mass.

HOW MOTION ANTAGONIZES GRAVITY.—The second way to neutralize gravity, is by *motion*. A ball thrown upwardly, antagonizes the force of gravity during the period of its ascent. In like manner, when an object is projected horizontally, while its mass is still the same, its weight is less.

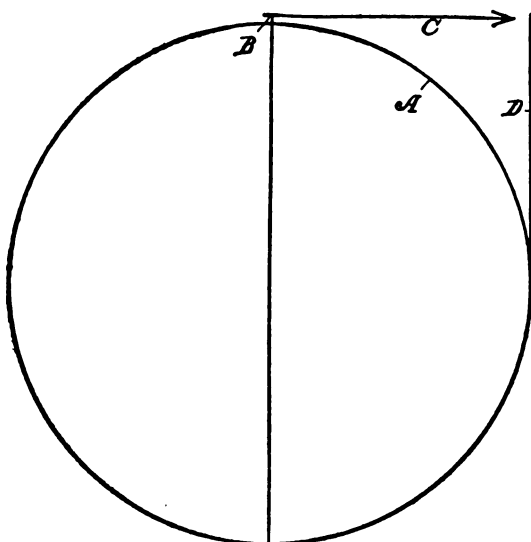
Motion is that which is constantly combating the action of gravity. A body moving in a circle must be acted upon by two forces, one which tends to draw it inwardly, and the other which seeks to throw it outwardly.

The former is called *centripetal*, and the latter *centrifugal* motion. *Gravity*, therefore, represents centripetal, and *motion* centrifugal force.

If the rotative speed of the earth should be retarded, all objects on the earth would be increased in weight, and if the motion should be accelerated

objects would become lighter, and if sufficient speed should be attained all matter would fly off the surface, just as dirt flies off the rim of a wheel at certain speeds.

A TANGENT.—When an object is thrown horizontally the line of flight is tangential to the earth,



*Fig. 1. Tangential Flight.*

or at right angles to the force of gravity. Such a course in a flying machine finds less resistance than if it should be projected upwardly, or directly opposite the centripetal pull.

TANGENTIAL MOTION REPRESENTS CENTRIFUGAL PULL.—A tangential motion, or a horizontal

movement, seeks to move matter away from the center of the earth, and any force which imparts a horizontal motion to an object exerts a centrifugal pull for that reason.

In Fig. 1, let A represent the surface of the earth, B the starting point of the flight of an object, and C the line of flight. That represents a tangential line. For the purpose of explaining the phenomena of tangential flight, we will assume that the missile was projected with a sufficient force to reach the vertical point D, which is 4000 miles from the starting point B.

In such a case it would now be over 5500 miles from the center of the earth, and the centrifugal pull would be decreased to such an extent that the ball would go on and on until it came within the sphere of influence from some other celestial body.

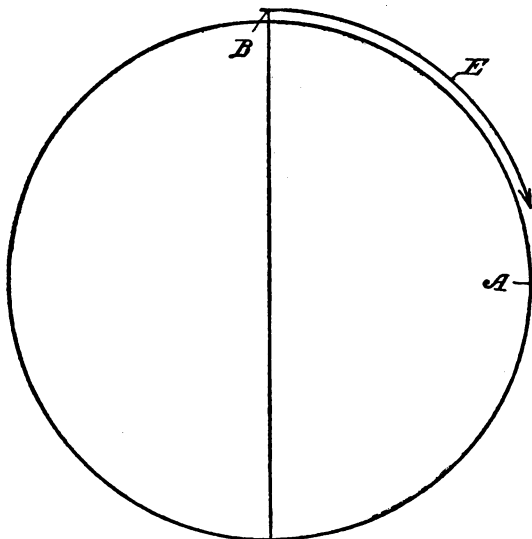
EQUALIZING THE TWO MOTIONS.—But now let us assume that the line of flight is like that shown at E, in Fig. 2, where it travels along parallel with the surface of the earth. In this case the force of the ball equals the centripetal pull,—or, to put it differently, the centrifugal equals the gravitational pull.

The constant tendency of the ball to fly off at a tangent, and the equally powerful pull of gravity acting against each other, produce a mo-



tion which is like that of the earth, revolving around the sun once every three hundred and sixty-five days.

It is a curious thing that neither Langley, nor any of the scientists, in treating of the matter of flight, have taken into consideration this quality

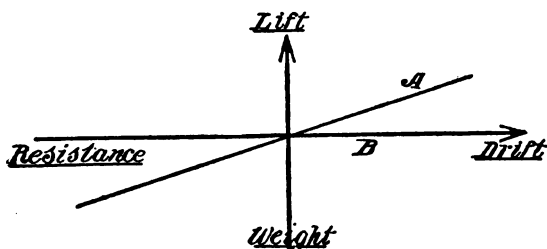


*Fig. 2. Horizontal Flight.*

of momentum, in their calculations of the elements of flight.

All have treated the subject as though the whole problem rested on the angle at which the planes were placed. At 45 degrees the lift and drift are assumed to be equal.

**LIFT AND DRIFT.**—The terms should be explained, in view of the frequent allusion which will be made to the terms hereinafter. *Lift* is the word employed to indicate the amount which a plane surface will support while in flight. *Drift* is the term used to indicate the resistance which is offered to a plane moving forwardly against the atmosphere.



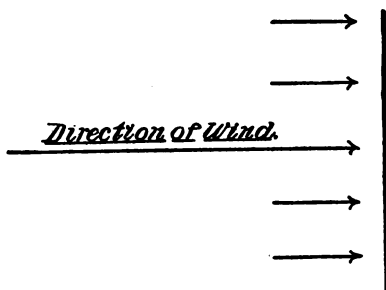
*Fig. 3. Lift and Drift.*

In Fig. 3 the plane A is assumed to be moving forwardly in the direction of the arrow B. This indicates the resistance. The vertical arrow C shows the direction of lift, which is the weight held up by the plane.

**NORMAL PRESSURE.**—Now there is another term much used which needs explanation, and that is *normal pressure*. A pressure of this kind against a plane is where the wind strikes it at right angles. This is illustrated in Fig. 4, in

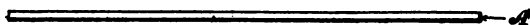
which the plane is shown with the wind striking it squarely.

It is obvious that the wind will exert a greater force against a plane when at its normal. On the



*Fig. 4. Normal Air Pressure.*

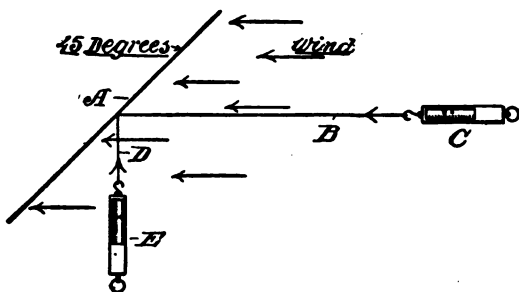
other hand, the least pressure against a plane is when it is in a horizontal position, because then the wind has no force against the surfaces, and the only effect on the drift is that which takes place when the wind strikes its forward edge.



*Fig. 5. Edge Resistance.*

HEAD RESISTANCE.—Fig. 5 shows such a plane, the only resistance being the thickness of the plane as at A. This is called *head resistance*, and on this subject there has been much controversy, and many theories, which will be considered under the proper headings.

If a plane is placed at an angle of 45 degrees the lift and the drift are the same, assumedly, because, if we were to measure the power required to drive it forwardly, it would be found to equal the weight necessary to lift it. That is, suppose we should hold a plane at that angle with a heavy wind blowing against it, and attach two pairs of scales to the plane, both would show the same pull.



*Fig. 6. Measuring Lift and Drift.*

MEASURING LIFT AND DRIFT.—In Fig. 6, A is the plane, B the horizontal line which attaches the plane to a scale C, and D the line attaching it to the scale E. When the wind is of sufficient force to hold up the plane, the scales will show the same pull, neglecting, of course, the weight of the plane itself.

PRESSURE AT DIFFERENT ANGLES.—What every one wants to know, and a subject on which a

great deal of experiment and time have been expended, is to determine what the pressures are at the different angles between the horizontal, and laws have been formulated which enable the pressures to be calculated.

**DIFFERENCE BETWEEN LIFT AND DRIFT IN MOTION.**—The first observation is directed to the differences that exist between the lift and drift, when the plane is placed at an angle of less than 45 degrees. A machine weighing 1000 pounds has always the same lift. Its mass does not change. Remember, now, we allude to its *mass*, or *density*.

We are not now referring to *weight*, because that must be taken into consideration, in the problem. As heretofore stated, when an object moves horizontally, it has less weight than when at rest. If it had the same weight it would not move forwardly, but come to rest.

When in motion, therefore, while the lift, so far as its mass is concerned, does not change, the drift does decrease, or the forward pull is less than when at 45 degrees, and the decrease is less and less until the plane assumes a horizontal position, where it is absolutely nil, if we do not consider head resistance.

**TABLES OF LIFT AND DRIFT.**—All tables of *Lift* and *Drift* consider only the air pressures. They

do not take into account the fact that momentum takes an important part in the translation of an object, like a flying machine.

A mass of material, weighing 1000 pounds while at rest, sets up an enormous energy when moving through the air at fifty, seventy-five, or one hundred miles an hour. At the latter speed the movement is about 160 feet per second, a motion which is nearly sufficient to maintain it in horizontal flight, independently of any plane surface.

Such being the case, why take into account only the angle of the plane? It is no wonder that aviators have not been able to make the theoretical considerations and the practical demonstrations agree.

**WHY TABLES OF LIFT AND DRIFT ARE WRONG.—**A little reflection will show why such tables are wrong. They were prepared by using a plane surface at rest, and forcing a blast of air against the plane placed at different angles; and for determining air pressures, this is, no doubt, correct. But it does not represent actual flying conditions. It does not show the conditions existing in an aeroplane while in flight.

To determine this, short of actual experiments with a machine in horizontal translation, is impossible, unless it is done by taking into account the factor due to momentum and the element at-

tributable to the lift of the plane itself due to its impact against the atmosphere.

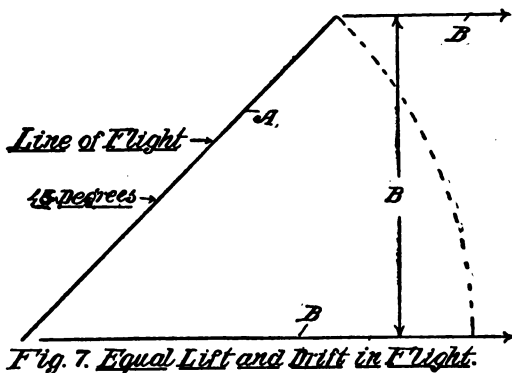
**LANGLEY'S LAW.**—The law enunciated by Langley is, that the greater the speed the less the power required to propel it. Water as a propelling medium has over seven hundred times more force than air. A vessel having, for instance, twenty horse power, and a speed of ten miles per hour, would require four times that power to drive it through the water at double the speed. The power is as the *square of the speed*.

With air the conditions are entirely different. The boat submergence in the water is practically the same, whether going ten or twenty miles an hour. The head resistance is the same, substantially, at all times in the case of the boat; with the flying machine the resistance of its sustaining surfaces decreases.

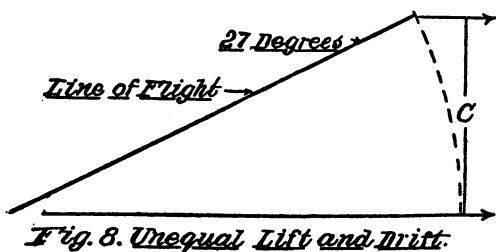
Without going into a too technical description of the reasoning which led to the discovery of the law of air pressures, let us try and understand it by examining the diagram, Fig. 7.

A represents a plane at an angle of 45 degrees, moving forwardly into the atmosphere in the direction of the arrows B. The measurement across the plane vertically, along the line B, which is called the *sine of the angle*, represents the surface impact of air against the plane.

In Fig. 8 the plane is at an angle of 27 degrees, which makes the distance in height across the line C just one-half the length of the line B of Fig. 7,



hence the surface impact of the air is one-half that of Fig. 7, and the drift is correspondingly decreased.



**MOVING PLANES VS. WINDS.**—In this way Boisset, Duchemin, Langley, and others, determined the comparative drift, and those results have been



largely relied upon by aviators, and assumed to be correct when applied to flying machines.

That they are not correct has been proven by the Wrights and others, the only explanation being that some errors had been made in the calculations, or that aviators were liable to commit errors in observing the true angle of the planes while in flight.

**MOMENTUM NOT CONSIDERED.**—The great factor of momentum has been entirely ignored, and it is our desire to press the important point on those who begin to study the question of flying machines.

**THE FLIGHT OF BIRDS.**—Volumes have been written concerning observations on the flight of birds. The marvel has been why do soaring birds maintain themselves in space without flapping their wings. In fact, it is a much more remarkable thing to contemplate why birds which depend on flapping wings can fly.

**THE DOWNWARD BEAT.**—It is argued that the downward beat of the wings is so much more rapid than the upward motion, that it gets an action on the air so as to force the body upwardly. This is disposed of by the wing motion of many birds, notoriously the crow, whose lazily-flapping wings can be readily followed by the eye, and the difference in movement, if any, is not perceptible.

**THE CONCAVED WING.**—It is also urged that the concave on the under side of the wing gives the quality of lift. Certain kinds of beetles, and particularly the common house fly, disprove that theory, as their wings are perfectly flat.

**FEATHER STRUCTURE CONSIDERED.**—Then the feather argument is advanced, which seeks to show that as each wing is made up of a plurality of feathers, overlapping each other, they form a sort of a valved surface, opening so as to permit air to pass through them during the period of their upward movement, and closing up as the wing descends.

It is difficult to perform this experiment with wings, so as to show such an individual feather movement. It is certain that there is nothing in the structure of the wing bone and the feather connection which points to any individual feather movement, and our observation is, that each feather is entirely too rigid to permit of such an opening up between them.

It is obvious that the wing is built up in that way for an entirely different reason. Soaring birds, which do not depend on the flapping motion, have the same overlapping feather formation.

**WEBBED WINGS.**—Furthermore, there are numerous flying creatures which do not have feath-

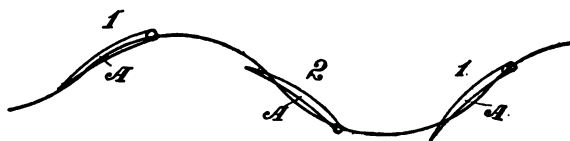
ered wings, but web-like structures, or like the house fly, in one continuous and unbroken plane.

That birds which fly with flapping wings derive their support from the air, is undoubtedly true, and that the lift produced is due, not to the form, or shape, or area of the wing, is also beyond question. The records show that every conceivable type of outlined structure is used by nature; the material and texture of the wings themselves differ to such a degree that there is absolutely no similarity; some have concaved under surfaces, and others have not; some fly with rapidly beating wings, and others with slow and measured movements; many of them fly with equal facility without flapping movements; and the proportions of weight to wing surface vary to such an extent that it is utterly impossible to use such data as a guide in calculating what the proper surface should be for a correct flying machine.

**THE ANGLE OF MOVEMENT.**—How, then, it may be asked, do they get their support? There must be something, in all this variety and diversity of form, of motion, and of characteristics, which supplies the true answer. The answer lies in the *angle of movement* of every wing motion, which is at the control of the bird, and if this is examined it will be found that it supplies the correct

answer to every type of wing which nature has made.

AN INITIAL IMPULSE OR MOVEMENT NECESSARY.—Let A, Fig. 9, represent the section of a bird's wing. All birds, whether of the soaring or the flapping kind, must have an initial forward movement in order to attain flight. This impulse is acquired either by running along the ground, or by a leap, or in dropping from a perch. Soaring birds cannot, by any possibility, begin flight, un-



*Fig. 9. Wing movement in Flight.*

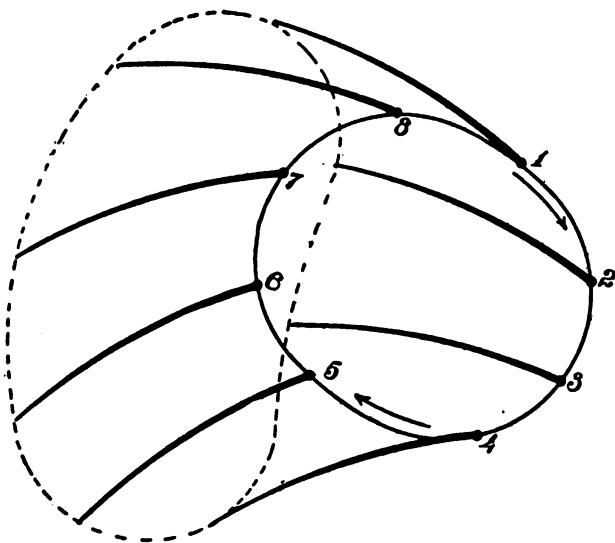
less there is such a movement to change from a position of rest to one of motion.

In the diagram, therefore, the bird, in moving forwardly, while raising the wing upwardly, depresses the rear edge of the wing, as in position 1, and when the wing beats downwardly the rear margin is raised, in relation to its front margin, as shown in position 2.

A WEDGING MOTION.—Thus the bird, by a wedge-like motion, gives a forwardly-propelling action, and as the rear margin has more or less flexure, its action against the air is less during its

upward beat, and this also adds to the upward lift of the body of the bird.

NO MYSTERY IN THE WAVE MOTION.—There is no mystery in the effect of such a wave-like motion, and it must be obvious that the humming bird, and like flyers, which poise at one spot, are



*Fig. 10. Evolution of Humming-Bird's Wings.*

able to do so because, instead of moving forwardly, or changing the position of its body horizontally, in performing the undulatory motion of the wing, it causes the body to rock, so that at the point where the wing joins the body, an elliptical motion is produced.

**HOW BIRDS POISE WITH FLAPPING WINGS.**—This is shown in Fig. 10, in which eight successive positions of the wing are shown, and wherein four of the position, namely, 1, 2, 3, and 4, represent the downward movement, and 6, 7, 8, and 9, the upward beat.

All the wing angles are such that whether the suspension point of each wing is moving downwardly, or upwardly, a support is found in some part of the wing.

**NARROW-WINGED BIRDS.**—Birds with rapid flapping motions have comparatively narrow wings, fore and aft. Those which flap slowly, and are not swift flyers, have correspondingly broader wings. The broad wing is also typical of the soaring birds.

But how do the latter overcome gravitation without exercising some sort of wing movement?

**INITIAL MOVEMENT OF SOARING BIRDS.**—Acute observations show that during the early stages of flight, before speed is acquired, they depend on the undulating movement of the wings, and some of them acquire the initial motion by flapping. When speed is finally attained it is difficult for the eye to note the motion of the wings.

**SOARING BIRDS MOVE SWIFTLY.**—Now, the first observation is, that soaring birds are swiftly-moving creatures. As they sail overhead ma-

jestically they seem to be moving slowly. But distance is deceptive. The soaring bird travels at great speeds, and this in itself should be sufficient to enable us to cease wondering, when it is remembered that swift translation decreases weight, so that this factor does not, under those conditions, operate against flight.

#### MUSCULAR ENERGY EXERTED BY SOARING BIRDS.

—It is not conceivable that the mere will of the bird would impel it forwardly, without it exerted some muscular energy to keep up its speed. The distance at which the bird performs this wonderful evolution is at such heights from the observer that the eye cannot detect a movement.

WINGS NOT MOTIONLESS.—While the wings appear to be absolutely motionless, it is more reasonable to assume that a slight sinuous movement, or a rocking motion is constantly kept up, which wedges forwardly with sufficient speed to compel momentum to maintain it in flight. To do so requires but a small amount of energy. The head resistance of the bird formation is reduced to a minimum, and at such high speeds the angle of incidence of the wings is very small, requiring but little aid to maintain it in horizontal flight.

## CHAPTER II

### PRINCIPLES OF AEROPLANE FLIGHT

FROM the foregoing chapter, while it may be rightly inferred that power is the true secret of aeroplane flight, it is desirable to point out certain other things which must be considered.

**SPEED AS ONE OF THE ELEMENTS.**—Every boy, probably, has at some time or other thrown small flat stones, called “skippers.” He has noticed that if they are particularly thin, and large in diameter, that there is a peculiar sailing motion, and that they move through the air in an undulating or wave-like path.

Two things contribute to this motion; one is the size of the skipper, relative to its weight, and the other is its speed. If the speed is slow it will quickly wend its way to the earth in a gradual curve. This curved line is called its *trajectory*. If it is not very large diametrically, in proportion to its weight, it will also make a gradual curve in descending, without “skimming” up and down in its flight.

**SHAPE AND SPEED.**—It has been observed, also,



that a round ball, or an object not flattened out, will make a regular curved path, whatever the speed may be.

It may be assumed, therefore, that the shape alone does not account for this sinuous motion; but that *speed* is the element which accounts for it. Such being the case it may be well to inquire into the peculiar action which causes a skipper to dart up and down, and why the path thus formed grows more and more accentuated as the speed increases.

As will be more fully described in a later chapter, the impact of air against a moving body does not increase in proportion to its speed, but in the ratio of the *square* of the speed.

**WHAT SQUARE OF THE SPEED MEANS.**—In mathematics a figure is squared when it is multiplied by itself. Thus,  $4 \times 4 = 16$ ;  $5 \times 5 = 25$ ; and so on, so that 16 is the square of 4, and 25 the square of 5. It has been found that a wind moving at the speed of 20 miles an hour has a striking or pushing force of 2 pounds on every square foot of surface.

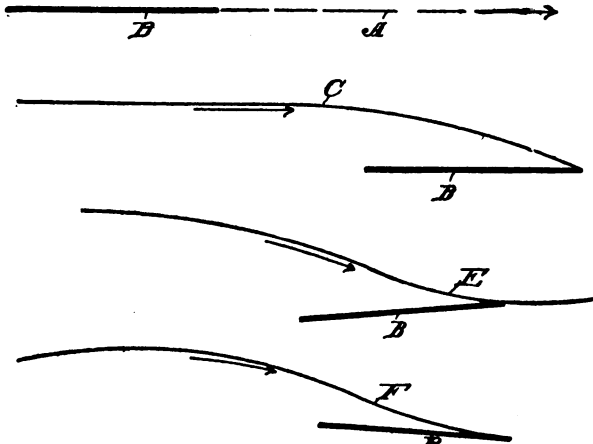
If the wind travels twice as fast, or 40 miles an hour, the pushing force is not 4 pounds, but 8 pounds. If the speed is 60 miles an hour the pushing force increases to 18 pounds.

**ACTION OF A SKIPPER.**—When the skipper leaves the hands of the thrower it goes through the air



in such a way that its flat surface is absolutely on a line with the direction in which it is projected.

At first it moves through the air solely by force of the power which impels it, and does not in any way depend on the air to hold it up. See Fig. 1, in which A represents the line of projection, and B the disk in its flight.



*Fig. 11. A Skipper in Flight.*


After it has traveled a certain distance, and the force decreases, it begins to descend, thus describing the line C, Fig. 1, the disk B, in this case descending, without changing its position, which might be described by saying that it merely settles down to the earth without changing its plane.

The skipper still remains horizontal, so that as it moves toward the earth its flat surface, which is now exposed to the action of the air, meets with a resistance, and this changes the angle of the disk, so that it will not be horizontal. Instead it assumes the position as indicated at D, and this impinging effect against the air causes the skipper to move upwardly along the line E, and having reached a certain limit, as at, say E, it automatically again changes its angle and moves downwardly along the path F, and thus continues to undulate, more or less, dependent on the combined action of the power and weight, or momentum, until it reaches the earth.

It is, therefore, clear that the atmosphere has an action on a plane surface, and that the extent of the action, to sustain it in flight, depends on two things, surface and speed.

Furthermore, the greater the speed the less the necessity for surface, and that for gliding purposes speed may be sacrificed, in a large measure, where there is a large surface.

This very action of the skipper is utilized by the aviator in *volplaning*,—that is, where the power of the engine is cut off, either by accident, or designedly, and the machine descends to the earth, whether in a long straight glide, or in a great circle.



As the machine nears the earth it is caused to change the angle of flight by the control mechanism so that it will dart upwardly at an angle, or downwardly, and thus enable the pilot to sail to another point beyond where he may safely land. This changing the course of the machine so that it will glide upwardly, means that the incidence of the planes has been changed to a positive angle.

**ANGLE OF INCIDENCE.**—In aviation this is a term given to the position of a plane, relative to the air against which it impinges. If, for instance, an aeroplane is moving through the air with the front margin of the planes higher than their rear margins, it is said to have the planes at a positive angle of incidence. If the rear margins are higher than the front, then the planes have a negative angle of incidence.

The word *incidence* really means, a falling upon, or against; and it will be seen, therefore, that the angle of incidence means the tilt of the planes in relation to the air which strikes it.

Having in view, therefore, that the two qualities, namely, speed and surface, bear an intimate relation with each other, it may be understood wherein mechanical flight is supposed to be analogous to bird flight.

**SPEED AND SURFACE.**—Birds which poise in the

air, like the humming bird, do so because they beat their wings with great rapidity. Those which soar, as stated, can do so only by moving through the atmosphere rapidly, or by having a large wing spread relative to the weight. It will thus be seen that speed and surface become the controlling factors in flight, and that while the latter may be entirely eliminated from the problem, speed is absolutely necessary under any and all conditions.

By speed in this connection is not meant high velocity, but that a movement, produced by power expressed in some form, is the sole and most necessary requisite to movement through the air with all heavier-than-air machines.

If sufficient power can be applied to an aeroplane, surface is of no consequence; shape need not be considered, and any sort of contrivance will move through the air horizontally.

CONTROL OF THE DIRECTION OF FLIGHT.—But the control of such a body, when propelled through space by force alone, is a different matter. To change the machine from a straight path to a curved one, means that it must be acted upon by some external force.

We have explained that power is something which is inherent in the thing itself. Now, in order that there may be a change imparted to a

moving mass, advantage must be taken of the medium through which it moves,—the atmosphere.

**VERTICAL CONTROL PLANES.**—If vertically-arranged planes are provided, either fore or aft of the machine, or at both ends, the angles of incidence may be such as to cause the machine to turn from its straight course.

In practice, therefore, since it is difficult to supply sufficient power to a machine to keep it in motion horizontally, at all times, aeroplanes are provided with supporting surfaces, and this aid in holding it up grows less and less as its speed increases.

But, however strong the power, or great the speed, its control from side to side is not dependent on the power of the engine, or the speed at which it travels through the air.

Here the size of the vertical planes, and their angles, are the only factors to be considered, and these questions will be considered in their proper places.

## CHAPTER III

### THE FORM OR SHAPE OF FLYING MACHINES

EVERY investigator, experimenter, and scientist, who has given the subject of flight study, proceeds on the theory that in order to fly man must copy nature, and make the machine similar to the type so provided.

THE THEORY OF COPYING NATURE.—If such is the case then it is pertinent to inquire which bird is the proper example to use for mechanical flight. We have shown that they differ so radically in every essential, that what would be correct in one thing would be entirely wrong in another.

The bi-plane is certainly not a true copy. The only thing in the Wright machine which in any way resembles the bird's wing, is the rounded end of the planes, and judging from other machines, which have square ends, this slight similarity does not contribute to its stability or otherwise help the structure.

The monoplane, which is much nearer the bird type, has also sounded wing ends, made not so



much for the purpose of imitating the wing of the bird, as for structural reasons.

**HULLS OF VESSELS.**—If some marine architect should come forward and assert that he intended to follow nature by making a boat with a hull of the shape or outline of a duck, or other swimming fowl, he would be laughed at, and justly so, because the lines of vessels which are most efficient are not made like those of a duck or other swimming creatures.

**MAN DOES NOT COPY NATURE.**—Look about you, and see how many mechanical devices follow the forms laid down by nature, or in what respect man uses the types which nature provides in devising the many inventions which ingenuity has brought forth.

**PRINCIPLES ESSENTIAL, NOT FORMS.**—It is essential that man shall follow nature's laws. He cannot evade the principles on which the operations of mechanism depend; but in doing so he has, in nearly every instance, departed from the *form* which nature has suggested, and made the machine irrespective of nature's type.

Let us consider some of these striking differences to illustrate this fact. Originally pins were stuck upon a paper web by hand, and placed in rows, equidistant from each other. This necessitates the coöperative function of the fingers and



the eye. An expert pin sticker could thus assemble from four to five thousand pins a day.

The first mechanical pinsticker placed over 500,000 pins a day on the web, rejecting every bent or headless pin, and did the work with greater accuracy than it was possible to do it by hand. There was not the suggestion of an eye, or a finger in the entire machine, to show that nature furnished the type.

NATURE NOT THE GUIDE AS TO FORMS.—Nature does not furnish a wheel in any of its mechanical expressions. If man followed nature's form in the building of the locomotive, it would move along on four legs like an elephant. Curiously enough, one of the first road wagons had "push legs,"—an instance where the mechanic tried to copy nature,—and failed.

THE PROPELLER TYPE.—The well known propeller is a type of wheel which has no prototype in nature. It is maintained that the tail of a fish in its movement suggested the propeller, but the latter is a long departure from it.

The Venetian rower, who stands at the stern, and with a long-bladed oar, fulcrumed to the boat's extremity, in making his graceful lateral oscillations, simulates the propelling motion of the tail in an absolutely perfect manner, but it is



not a propeller, by any means comparable to the kind mounted on a shaft, and revoluble.

How much more efficient are the spirally-formed blades of the propeller than any wing or fin movement, in air or sea. There is no comparison between the two forms in utility or value.

Again, the connecting points of the arms and legs with the trunk of a human body afford the most perfect types of universal joints which nature has produced. The man-made universal joint has a wider range of movement, possesses greater strength, and is more perfect mechanically. A universal joint is a piece of mechanism between two elements, which enables them to be turned, or moved, at any angle relative to each other.

But why multiply these instances. Like samples will be found on every hand, and in all directions, and man, the greatest of all of nature's products, while imperfect in himself, is improving and adapting the things he sees about him.

WHY SPECIALLY-DESIGNED FORMS IMPROVE NATURAL STRUCTURES.—The reason for this is, primarily, that the inventor must design the article for its special work, and in doing so makes it better adapted to do that particular thing. The hands and fingers can do a multiplicity of things,

but it cannot do any particular work with the facility or the degree of perfection that is possible with the machine made for that purpose.

The hands and fingers will bind a sheaf of wheat, but it cannot compete with the special machine made for that purpose. On the other hand the binder has no capacity to do anything else than what it was specially made for.

In applying the same sort of reasoning to the building of flying machines we must be led to the conclusion that the inventor can, and will, eventually, bring out a form which is as far superior to the form which nature has taught us to use as the wonderful machines we see all about us are superior to carry out the special work they were designed to do.

On land, man has shown this superiority over matter, and so on the sea. Singularly, the submarines, which go beneath the sea, are very far from that perfected state which have been attained by vessels sailing on the surface; and while the means of transportation on land are arriving at points where the developments are swift and remarkable, the space above the earth has not yet been conquered, but is going through that same period of development which precedes the production of the true form itself.

**MECHANISM DEVOID OF INTELLIGENCE.**—The great

error, however, in seeking to copy nature's form in a flying machine is, that we cannot invest the mechanism with that which the bird has, namely, a guiding intelligence to direct it instinctively, as the flying creature does.

**A MACHINE MUST HAVE A SUBSTITUTE FOR INTELLIGENCE.**—Such being the case it must be endowed with something which is a substitute. A bird is a supple, pliant organism; a machine is a rigid structure. One is capable of being directed by a mind which is a part of the thing itself; while the other must depend on an intelligence which is separate from it, and not responsive in feeling or movement.

For the foregoing reasons success can never be attained until some structural form is devised which will consider the flying machine independently of the prototypes pointed out as the correct things to follow. It does not, necessarily, have to be unlike the bird form, but we do know that the present structures have been made and insisted upon blindly, because of this wrong insistence on forms.

**STUDY OF BIRD FLIGHT USELESS.**—The study of the flight of birds has never been of any special value to the art. Volumes have been written on the subject. The Seventh Duke of Argyle, and later, Pettigrew, an Englishman, contributed a

vast amount of written matter on the subject of bird flight, in which it was sought to show that soaring birds did not exert any power in flying.

Writers and experimenters do not agree on the question of the propulsive power, or on the form or shape of the wing which is most effective, or in the matter of the relation of surface to weight, nor do they agree in any particular as to the effect and action of matter in the soaring principle.

Only a small percentage of flying creatures use motionless wings as in soaring. By far, the greater majority use beating wings, a method of translation in air which has not met with success in any attempts on the part of the inventor.

Nevertheless, experimenting has proceeded on lines which seek to recognize nature's form only, while avoiding the best known and most persistent type.

**SHAPE OF SUPPORTING SURFACES.**—When we examine the prevailing type of supporting surfaces we cannot fail to be impressed with one feature, namely, the determination to insist on a broad spread of plane surface, in imitation of the bird with outstretched wings.

**THE TROUBLE ARISING FROM OUTSTRETCHED WINGS.**—This form of construction is what brings all the troubles in its train. The literature on aviation is full of arguments on this subject, all

declaring that a wide spread is essential, because, —birds fly that way.

These assertions are made notwithstanding the fact that only a few years ago, in the great exhibit of aeroplanes in Paris, many unique forms of machines were shown, all of them capable of flying, as proven by numerous experiments, and among them were a half dozen types whose length fore and aft were much greater than transversely, and it was particularly noted that they had most wonderful stability.

**DENSITY OF THE ATMOSPHERE.**—Experts declare that the density of the atmosphere varies throughout,—that it has spots here and there which are, apparently, like holes, so that one side or the other of the machine will, unaccountably, tilt, and sometimes the entire machine will suddenly drop for many feet, while in flight.

**ELASTICITY OF THE AIR.**—Air is the most elastic substance known. The particles constituting it are constantly in motion. When heat or cold penetrate the mass it does so, in a general way, so as to permeate the entire body, but the conductivity of the atmospheric gases is such that the heat does not reach all parts at the same time.

**AIR HOLES.**—The result is that varying strata of heat and cold seem to be superposed, and also distributed along the route taken by a machine,

causing air currents which vary in direction and intensity. When, therefore, a rapidly-moving machine passes through an atmosphere so disturbed, the surfaces of the planes strike a mass of air moving, we may say, first toward the plane, and the next instant the current is reversed, and the machine drops, because its support is temporarily gone, and the aviator experiences the sensation of going into a "hole."

RESPONSIBILITY FOR ACCIDENTS.—These so-called "holes" are responsible for many accidents. The outstretched wings, many of them over forty feet from tip to tip, offer opportunities for a tilt at one end or the other, which has sent so many machines to destruction.

The high center of gravity in all machines makes the weight useless to counterbalance the rising end or to hold up the depressed wing.

All aviators agree that these unequal areas of density extend over small spaces, and it is, therefore, obvious that a machine which is of such a structure that it moves through the air broadside on, will be more liable to meet these inequalities than one which is narrow and does not take in such a wide path.

Why, therefore, persist in making a form which, by its very nature, invites danger? Because birds fly that way!

**THE TURNING MOVEMENT.**—This structural arrangement accentuates the difficulty when the machine turns. The air pressure against the wing surface is dependent on the speed. The broad outstretched surfaces compel the wing at the outer side of the circle to travel faster than the inner one. As a result, the outer end of the aeroplane is elevated.

**CENTRIFUGAL ACTION.**—At the same time the running gear, and the frame which carries it and supports the machine while at rest, being below the planes, a centrifugal force is exerted, when turning a circle, which tends to swing the wheels and frame outwardly, and thereby still further elevating the outer end of the plane.

**THE WARPING PLANES.**—The only remedy to meet this condition is expressed in the mechanism which wraps or twists the outer ends of the planes, as constructed in the Wright machine, or the ailerons, or small wings at the rear margins of the planes, as illustrated by the Farman machine. The object of this arrangement is to decrease the angle of incidence at the rising end, and increase the angle at the depressed end, and thus, by manually-operated means keep the machine on an even keel.



## CHAPTER IV

### FORE AND AFT CONTROL

**THERE** is no phase of the art of flying more important than the fore and aft control of an airship. Lateral stability is secondary to this feature, for reasons which will appear as we develop the subject.

**THE BIRD TYPE OF FORE AND AFT CONTROL.**—Every aeroplane follows the type set by nature in the particular that the body is caused to oscillate on a vertical fore and aft plane while in flight. The bird has one important advantage, however, in structure. Its wing has a flexure at the joint, so that its body can so oscillate independently of the angle of the wings.

The aeroplane has the wing firmly fixed to the body, hence the only way in which it is possible to effect a change in the angle of the wing is by changing the angle of the body. To be consistent the aeroplane should be so constructed that the angle of the supporting surfaces should be movable, and not controllable by the body.

The bird, in initiating flight from a perch, darts

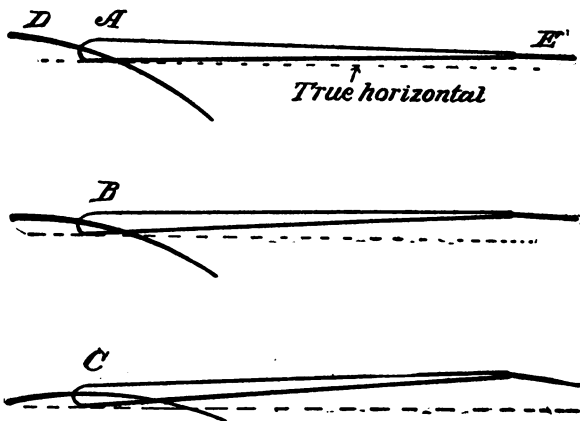
downwardly, and changes the angle of the body to correspond with the direction of the flying start. When it alights the body is thrown so that its breast banks against the air, but in ordinary flight its wings only are used to change the angle of flight.

ANGLE AND DIRECTION OF FLIGHT.—In order to become familiar with terms which will be frequently used throughout the book, care should be taken to distinguish between the terms *angle* and *direction* of flight. The former has reference to the up and down movement of an aeroplane, whereas the latter is used to designate a turning movement to the right or to the left.

WHY SHOULD THE ANGLE OF THE BODY CHANGE? —The first question that presents itself is, why should the angle of the aeroplane body change? Why should it be made to dart up and down and produce a sinuous motion? Why should its nose tilt toward the earth, when it is descending, and raise the forward part of the structure while ascending?

The ready answer on the part of the bird-form advocate is, that nature has so designed a flying structure. The argument is not consistent, because in this respect, as in every other, it is not made to conform to the structure which they seek to copy.

CHANGING ANGLE OF BODY NOT SAFE.—Furthermore, there is not a single argument which can be advanced in behalf of that method of building, which proves it to be correct. Contrariwise, an analysis of the flying movement will show that it is the one feature which has militated against safety, and that machines will never be safe so long as the angle of the body must be depended upon to control the angle of flying.

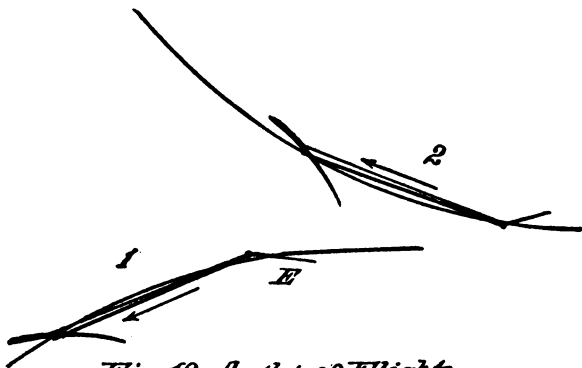


*Fig. 11.<sup>a</sup> Monoplane in Flight.*

In Fig. 11a three positions of a monoplane are shown, each in horizontal flight. Let us say that the first figure A is going at 40 miles per hour, the second, B, at 50, and the third, C, at 60 miles. The body in A is nearly horizontal, the angle of

the plane D being such that, with the tail E also horizontal, an even flight is maintained.

When the speed increases to 50 miles an hour, the angle of incidence in the plane D must be decreased, so that the rear end of the frame must be raised, which is done by giving the tail an angle of incidence, otherwise, as the upper side of the tail should meet the air it would drive the rear end of the frame down, and thus defeat the attempt to elevate that part.



*Fig. 12. Angles of Flight.*

As the speed increases ten miles more, the tail is swung down still further and the rear end of the frame is now actually above the plane of flight. In order, now, to change the angle of flight, without altering the speed of the machine, the tail is used to effect the control.

Examine the first diagram in Fig. 12. This

shows the tail E still further depressed, and the air striking its lower side, causes an upward movement of the frame at that end, which so much decreases the angle of incidence that the aeroplane darts downwardly.

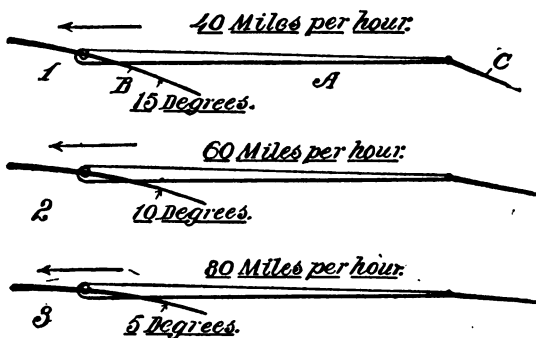
In order to ascend, the tail, as shown in the second diagram, is elevated so as to depress the rear end, and now the sustaining surface shoots upwardly.

Suppose that in either of the positions 1 or 2, thus described, the aviator should lose control of the mechanism, or it should become deranged or "stick," conditions which have existed in the history of the art, what is there to prevent an accident?

In the first case, if there is room, the machine will loop the loop, and in the second case the machine will move upwardly until it is vertical, and then, in all probability, as its propelling power is not sufficient to hold it in that position, like a helicopter, and having absolutely no wing supporting surface when in that position, it will dart down tail foremost.

**A NON-CHANGING BODY.**—We may contrast the foregoing instances of flight with a machine having the sustaining planes hinged to the body in such a manner as to make the disposition of its

angles synchronous with the tail. In other words, see how a machine acts that has the angle of flight controllable by both planes,—that is, the sustaining planes, as well as the tail.



*Fig. 13. Planes on Non-changing Body.*

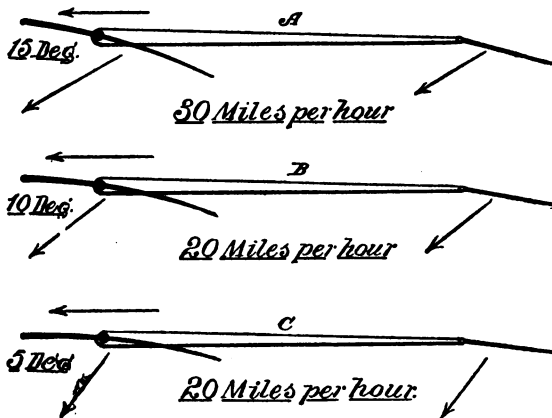
In Fig. 13 let the body of the aeroplane be horizontal, and the sustaining planes B disposed at the same angle, which we will assume to be 15 degrees, this being the imaginary angle for illustrative purposes, with the power of the machine to drive it along horizontally, as shown in position 1.

In position 2 the angles of both planes are now at 10 degrees, and the speed 60 miles an hour, which still drives the machine forward horizontally.

In position 3 the angle is still less, being now

only 5 degrees but the speed is increased to 80 miles per hour, but in each instance the body of the machine is horizontal.

Now it is obvious that in order to ascend, in either case, the changing of the planes to a greater angle would raise the machine, but at the same time keep the body on an even keel.

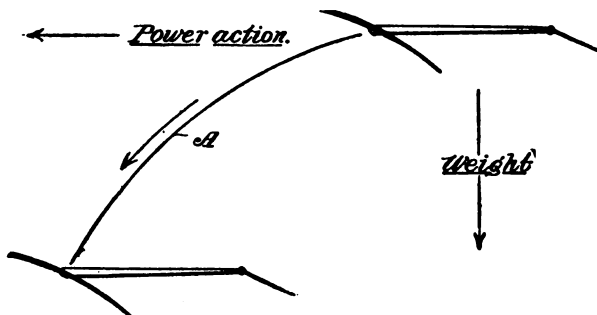


*Fig. 14. Descent with Non-changing Body*

DESCENDING POSITIONS BY POWER CONTROL.—In Fig. 14 the planes are the same angles in the three positions respectively, as in Fig. 13, but now the power has been reduced, and the speeds are 30, 25, and 20 miles per hour, in positions A, B and C.

Suppose that in either position the power should cease, and the control broken, so that it would be

impossible to move the planes. When the machine begins to lose its momentum it will descend on a curve shown, for instance, in Fig. 15, where position 1 of Fig. 14 is taken as the speed and angles of the plane when the power ceased.



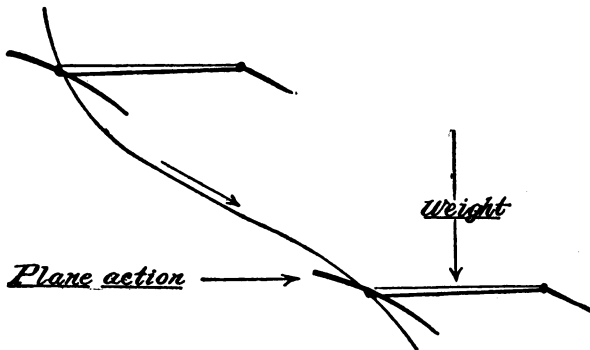
*Fig. 15. Utilizing Momentum*

**CUTTING OFF THE POWER.**—This curve, A, may reach that point where momentum has ceased as a forwardly-propelling factor, and the machine now begins to travel rearwardly. (Fig. 16.) It has still the entire supporting surfaces of the planes. It cannot loop-the-loop, as in the instance where the planes are fixed immovably to the body.

Carefully study the foregoing arrangement, and it will be seen that it is more nearly in accord with the true flying principle as given by nature than the vaunted theories and practices now indulged in and so persistently adhered to.



The body of a flying machine should not be oscillated like a lever. The support of the aeroplane should never be taken from it. While it may be impossible to prevent a machine from coming down, it can be prevented from overturning, and this can be done without in the least detracting from it structurally.



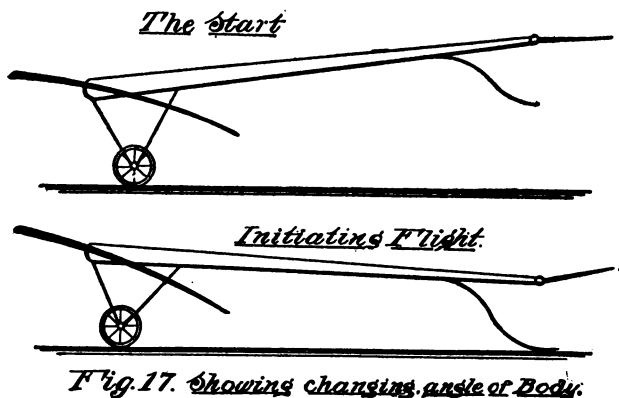
*Fig. 16. Reversing motion.*

The plan suggested has one great fault, however. It will be impossible with such a structure to cause it to fly upside down. It does not present any means whereby dare-devil stunts can be performed to edify the grandstand. In this respect it is not in the same class with the present types.

**THE STARTING MOVEMENT.**—Examine this plan from the position of starting, and see the advantages it possesses. In these illustrations we have used, for convenience only, the monoplane

type, and it is obvious that the same remarks apply to the bi-plane.

Fig. 17 shows the starting position of the stock monoplane, in position 1, while it is being initially run over the ground, preparatory to launching. Position 2 represents the negative angle at which

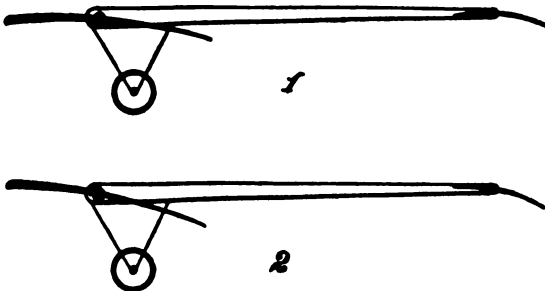


the tail is thrown, which movement depresses the rear end of the frame and thus gives the supporting planes the proper angle to raise the machine, through a positive angle of incidence, of the plane.

THE SUGGESTED TYPE.—In Fig. 18 the suggested type is shown with the body normally in a horizontal position, and the planes in a neutral position, as represented in position 1. When sufficient speed had been attained both planes are turned to the same angle, as in position 2, and

flight is initiated without the abnormal oscillating motion of the body.

But now let us see what takes place the moment the present type is launched. If, by any error on the part of the aviator, he should fail to readjust the tail to a neutral or to a proper angle of incidence, after leaving the ground, the machine would try to perform an over-head loop.



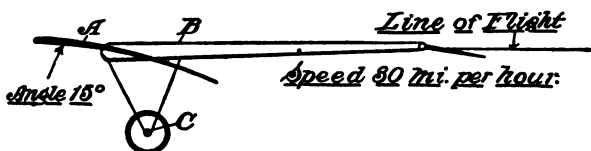
*Fig. 18. Shows non-changing angle of frame*

The suggested plan does not require this caution. The machine may rise too rapidly, or its planes may be at too great an angle for the power or the speed, or the planes may be at too small an angle, but in either case, neglect would not turn the machine to a dangerous position.

These suggestions are offered to the novice, because they go to the very foundation of a correct understanding of the principles involved in the building and in the manipulation of flying ma-

chines, and while they are counter to the beliefs of aviators, as is shown by the persistency in adhering to the old methods, are believed to be mechanically correct, and worthy of consideration.

**THE LOW CENTER OF GRAVITY.**—But we have still to examine another feature which shows the wrong principle in the fixed planes. The question is often asked, why do the builders of aeroplanes place most of the weight up close to the planes? It must be obvious to the novice that the lower the weight the less liability of overturning.



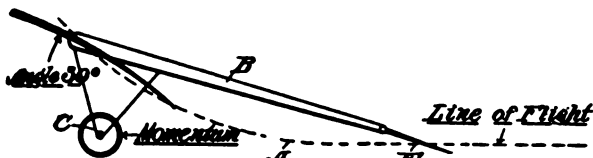
*Fig. 19. Normal flight, with Propeller pulling.*

**FORE AND AFT OSCILLATIONS.**—The answer is, that when the weight is placed below the planes it acts like a pendulum. When the machine is traveling forward, and the propeller ceases its motion, as it usually does instantaneously, the weight, being below, and having a certain momentum, continues to move on, and the plane surface meeting the resistance just the same, and having no means to push it forward, a greater angle of resistance is formed.

In Fig. 19 this action of the two forces is illus-

trated. The plane at the speed of 30 miles is at an angle of 15 degrees, the body B of the machine being horizontal, and the weight C suspended directly below the supporting surfaces.

The moment the power ceases the weight continues moving forwardly, and it swings the forward end of the frame upwardly, Fig. 20, and we now



*Fig. 20. Action when Propeller ceases to pull*

have, as in the second figure, a new angle of incidence, which is 30 degrees, instead of 12. It will be understood that in order to effect a change in the position of the machine, the forward end ascends, as shown by the dotted line A.

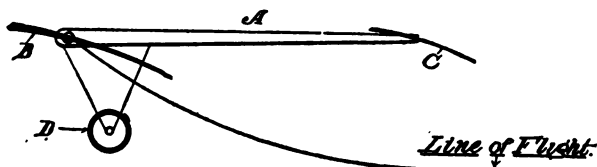
The weight C having now ascended as far as possible forward in its swing, and its motion checked by the banking action of the plan it will again swing back, and again carry with it the frame, thus setting up an oscillation, which is extremely dangerous.

The tail E, with its unchanged angle, does not, in any degree, aid in maintaining the frame on an even keel. Being nearly horizontal while in

flight, if not at a negative angle, it actually assists the forward end of the frame to ascend.

APPLICATION OF THE NEW PRINCIPLE.—Extending the application of the suggested form, let us see wherein it will prevent this pendulous motion at the moment the power ceases to exert a forwardly-propelling force.

In Fig. 21 the body A is shown to be equipped with the supporting plane B and the tail C, so



*Fig. 21 Synchronously moving Planes.*

they are adjustable simultaneously at the same angle, and the weight D is placed below, similar to the other structure.

At every moment during the forward movement of this type of structure, the rear end of the machine has a tendency to move upwardly, the same as the forward end, hence, when the weight seeks, in this case to go on, it acts on the rear plane, or tail, and causes that end to raise, and thus by mutual action, prevents any pendulous swing.

LOW WEIGHT NOT NECESSARY WITH SYNCHRON-

OUSLY-MOVING WINGS.—A little reflection will convince any one that if the two wings move in harmony, the weight does not have to be placed low, and thus still further aid in making a compact machine. By increasing the area of the tail, and making that a true supporting surface, instead of a mere idler, the weight can be moved further back, the distance transversely across the planes may be shortened, and in that way still further increase the lateral stability.

## CHAPTER V

### DIFFERENT MACHINE TYPES AND THEIR CHARACTERISTICS

THERE are three distinct types of heavier-than-air machines, which are widely separated in all their characteristics, so that there is scarcely a single feature in common.

Two of them, the *aeroplane*, and the *orthopter*, have prototypes in nature, and are distinguished by their respective similarities to the soaring birds, and those with flapping wings.

The *Helicopter*, on the other hand, has no antecedent type, but is dependent for its raising powers on the pull of a propeller, or a plurality of them, constructed, as will be pointed out hereinafter.

AEROPLANES.—The only form which has met with any success is the aeroplane, which, in practice, is made in two distinct forms, one with a single set of supporting planes, in imitation of birds, and called a *monoplane*; and the other having two wings, one above the other, and called the *bi-plane*, or *two-planes*.



All machines now on the market which do not depend on wing oscillations come under those types.

**THE MONOPLANE.**—The single plane type has some strong claims for support. First of these is the comparatively small head resistance, due to the entire absence of vertical supporting posts, which latter are necessary with the biplane type. The bracing supports which hold the outer ends of the planes are composed of wires, which offer but little resistance, comparatively, in flight.

**ITS ADVANTAGES.**—Then the vertical height of the machine is much less than in the biplane. As a result the weight, which is farther below the supporting surface than in the biplane, aids in maintaining the lateral stability, particularly since the supporting frame is higher.

Usually, for the same wing spread, the monoplane is narrower, laterally, which is a further aid to prevent tilting.

**ITS DISADVANTAGES.**—But it also has disadvantages which must be apparent from its structure. As all the supporting surface is concentrated in half the number of planes, they must be made of greater width fore and aft, and this, as we shall see, later on, proves to be a disadvantage.

It is also doubted whether the monoplane can

be made as strong structurally as the other form, owing to the lack of the truss formation which is the strong point with the superposed frame. A truss is a form of construction where braces can be used from one member to the next, so as to brace and stiffen the whole.

THE BIPLANE.—Nature does not furnish a type of creature which has superposed wings. In this particular the inventor surely did not follow nature. The reasons which led man to employ this type may be summarized as follows:

In experimenting with planes it is found that a broad fore and aft surface will not lift as much as a narrow plane. This subject is fully explained in the chapter on *The Lifting Surfaces of Planes*. In view of that the technical descriptions of the operation will not be touched upon at this place, except so far as it may be necessary to set forth the present subject.

This peculiarity is due to the accumulation of a mass of moving air at the rear end of the plane, which detracts from its lifting power. As it would be a point of structural weakness to make the wings narrow and very long, Wenham many years ago suggested the idea of placing one plane above the other, and later on Chanute, an engineer, used that form almost exclusively, in experimenting with his gliders.

It was due to his influence that the Wrights adopted that form in their gliding experiments, and later on constructed their successful flyers in that manner. Originally the monoplane was the type generally employed by experimenters, such as Lilienthal, and others.

**STABILITY IN BIPLANES.**—Biplanes are not naturally as stable laterally as the monoplane. The reason is, that a downward tilt has the benefit of only a narrow surface, comparable with the monoplane, which has broadness of wing.

To illustrate this, let us assume that we have a biplane with planes five feet from front to rear, and thirty-six feet in length. This would give two planes with a sustaining surface of 360 square feet. The monoplane would, probably, divide this area into one plane eight and a half feet from front to rear, and 42 feet in length.

In the monoplane each wing would project out about three feet more on each side, but it would have eight and a half feet fore and aft spread to the biplane's five feet, and thus act as a greater support.

**THE ORTHOPTER.**—The term orthopter, or ornithopter, meaning bird wing, is applied to such flying machines as depend on wing motion to support them in the air.

Unquestionably, a support can be obtained by

beating on the air but to do so it is necessary to adopt the principle employed by nature to secure an upward propulsion. As pointed out elsewhere, it cannot be the concaved type of wing, or its shape, or relative size to the weight it must carry.

As nature has furnished such a variety of data on these points, all varying to such a remarkable degree, we must look elsewhere to find the secret. Only one other direction offers any opportunity, and that is in the individual wing movement.

NATURE'S TYPE NOT UNIFORM.—When this is examined, the same obscurity surrounds the issue. Even the speeds vary to such an extent that when it is tried to differentiate them, in comparison with form, shape, and construction, the experimenter finds himself wrapt in doubt and perplexity.

But birds do fly, notwithstanding this wonderful array of contradictory exhibitions. Observation has not enabled us to learn why these things are so. High authorities, and men who are expert aviators, tell us that the bird flies because it is able to pick out ascending air currents.

THEORIES ABOUT FLIGHT OF BIRDS.—Then we are offered the theory that the bird has an instinct which tells it just how to balance in the air when its wings are once set in motion. Fre-

quently, what is taken for instinct, is something entirely different.

It has been assumed, for instance, that a cyclist making a turn at a rapid speed, and a bird flying around a circle will throw the upper part of the body inwardly to counteract the centrifugal force which tends to throw it outwardly.

Experiments with the monorail car, which is equipped with a gyroscope to hold it in a vertical position, show that when the car approaches a curve the car will lean inwardly, exactly the same as a bird, or a cyclist, and when a straight stretch is reached, it will again straighten up.

INSTINCT.—Now, either the car, so equipped possesses instinct, or there must be a principle in the laws of nature which produces the similarity of action.

In like manner there must be some principle that is entirely independent of the form of matter, or its arrangement, which enables the bird to perform its evolutions. We are led to believe from all the foregoing considerations that it is the manner or the *form of the motion*.

MODE OF MOTION.—In this respect it seems to be comparable in every respect to the great and universal law of the motions in the universe. Thus, light, heat and electricity are the same, the

manifestations being unlike only because they have different *modes of motion*.

Everything in nature manifests itself by motion. It is the only way in which nature acts. Every transformation from one thing to another, is by way of a movement which is characteristic in itself.

Why, then, should this great mystery of nature, act unlike the other portions of which it is a part?

**THE WING STRUCTURE.**—The wing structure of every flying creature that man has examined, has one universal point of similarity, and that is the manner of its connection with the body. It is a sort of universal joint, which permits the wing to swing up and down, perform a gyratory movement while doing so, and folds to the rear when at rest.

Some have these movements in a greater or less degree, or capable of a greater range; but the joint is the same, with scarcely an exception. When the stroke of the wing is downwardly the rear margin is higher than the front edge, so that the downward beat not only raises the body upwardly, but also propels it forwardly.

**THE WING MOVEMENT.**—The moment the wing starts to swing upwardly the rear end is de-

pressed, and now, as the bird is moving forwardly, the wing surface has a positive angle of incidence, and as the wing rises while the forward motion is taking place, there is no resistance which is effective enough to counteract the momentum which has been set up.

The great problem is to put this motion into a mechanical form. The trouble is not ascribable to the inability of the mechanic to describe this movement. It is an exceedingly simple one. The first difficulty is in the material that must be used. Lightness and strength for the wing itself are the first requirements. Then rigidity in the joint and in the main rib of the wing, are the next considerations.

In these respects the ability of man is limited. The wing ligatures of flying creatures is exceedingly strong, and flexible; the hollow bone formation and the feathers are extremely light, compared with their sustaining powers.

**THE HELICOPTER MOTION.**—The helicopter, or *helix-wing*, is a form of flying machine which depends on revolving screws to maintain it in the air. Many propellers are now made, six feet in length, which have a pull of from 400 to 500 pounds. If these are placed on vertically-disposed shafts they would exert a like power to raise a machine from the earth.

Obviously, it is difficult to equip such a machine with planes for sustaining it in flight, after it is once in the air, and unless such means are provided the propellers themselves must be the mechanism to propel it horizontally.

This means a change of direction of the shafts which support the propellers, and the construction is necessarily more complicated than if they were held within non-changeable bearings.

This principle, however, affords a safer means of navigating than the orthopter type, because the blades of such an instrument can be forced through the air with infinitely greater speed than beating wings, and it devolves on the inventor to devise some form of apparatus which will permit the change of pull from a vertical to a horizontal direction while in flight.



## CHAPTER VI

### THE LIFTING SURFACES OF AEROPLANES

THIS subject includes the form, shape and angle of planes, used in flight. It is the direction in which most of the energy has been expended in developing machines, and the true form is still involved in doubt and uncertainty.

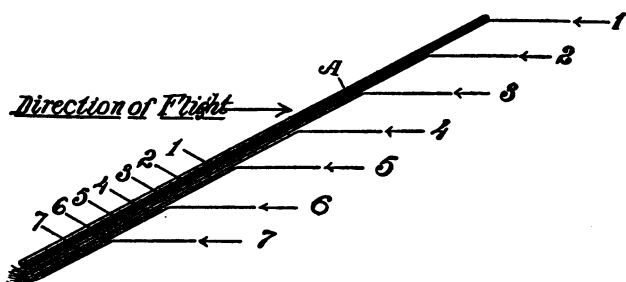
RELATIVE SPEED AND ANGLE.—The relative speed and angle, and the *camber*, or the curved formation of the plane, have been considered in all their aspects, so that the art in this respect has advanced with rapid strides.

NARROW PLANES MOST EFFECTIVE.—It was learned, in the early stages of the development by practical experiments, that a narrow plane, fore and aft, produces a greater lift than a wide one, so that, assuming the plane has 100 square feet of sustaining surface, it is far better to make the shape five feet by twenty than ten by ten.

However, it must be observed, that to use the narrow blade effectively, it must be projected through the air with the long margin forwardly.

Its sustaining power per square foot of surface is much less if forced through the air lengthwise.

Experiments have shown why a narrow blade has proportionally a greater lift, and this may be more clearly understood by examining the illustrations which show the movement of planes through the air at appropriate angles.



*Fig. 22. Stream lines along a plane.*

STREAM LINES ALONG A PLANE.—In Fig. 22, A is a flat plane, which we will assume is 10 feet from the front to the rear margin. For convenience seven stream lines of air are shown, which contact with this inclined surface. The first line 1, after the contact at the forward end, is driven downwardly along the surface, so that it forms what we might term a moving film.

The second air stream 2, strikes the first stream, followed successively by the other streams, 3, 4, and so on, each succeeding stream being compelled to ride over, or along on the preceding mass of

cushioned air, the last lines, near the lower end, being, therefore, at such angles, and contacting with such a rapidly-moving column, that it produces but little lift in comparison with the 1st, 2d and 3d stream lines. These stream lines are taken by imagining that the air approaches and contacts with the plane only along the lines indicated in the sketch, although they also in practice are active against every part of the plane.

**THE CENTER OF PRESSURE.**—In such a plane the *center of pressure* is near its upper end, probably near the line 3, so that the greater portion of the lift is exerted by that part of the plane above line 3.

**AIR LINES ON THE UPPER SIDE OF THE PLANE.**—Now, another factor must be considered, namely, the effect produced on the upper side of the plane, over which a rarefied area is formed at certain points, and, in practice, this also produces, or should be utilized to effect a lift.

**RAREFIED AREA.**—What is called a *rarefied area*, has reference to a state or condition of the atmosphere which has less than the normal pressure or quantity of air. Thus, the pressure at sea level, is about  $14\frac{3}{4}$  per square inch.

As we ascend the pressure grows less, and the air is thus rarer, or, there is less of it. This is a condition which is normally found in the atmos-

phere. Several things tend to make a rarefied condition. One is altitude, to which we have just referred.

Then heat will expand air, making it less dense, or lighter, so that it will move upwardly, to be replaced by a colder body of air. In aeronautics neither of these conditions is of any importance in considering the lifting power of aeroplane surfaces.

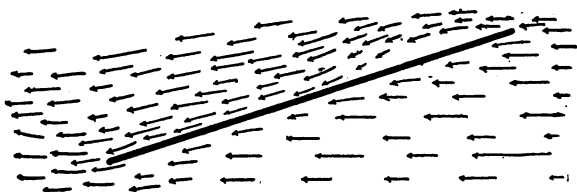
**RAREFACTION PRODUCED BY MOTION.**—The third rarefied condition is produced by *motion*, and generally the area is very limited when brought about by this means. If, for instance, a plane is held horizontally and allowed to fall toward the earth, it will be retarded by two forces, namely, compression and rarefaction, the former acting on the under side of the plane, and the latter on the upper side.

Of the two rarefaction is the most effectual, and produces a greater effect than compression. This may be proven by compressing air in a long pipe, and noting the difference in gauge pressure between the ends, and then using a suction pump on the same pipe.

When a plane is forced through the air at any angle, a rarefied area is formed on the side which is opposite the one having the positive angle of incidence.

If the plane can be so formed as to make a large and effective area it will add greatly to the value of the sustaining surface.

Unfortunately, the long flat plane does not lend any aid in this particular, as the stream line flows down along the top, as shown in Fig. 23, without being of any service.



*Fig. 23. Airlines on the upper side of a Plane.*

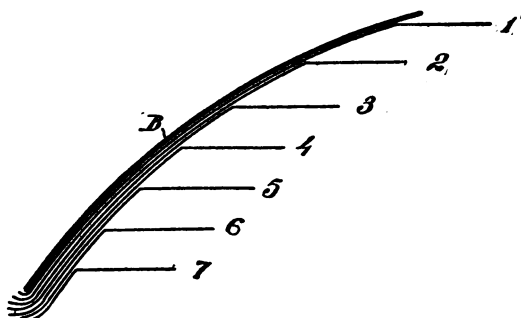
**THE CONCAVED PLANE.**—These considerations led to the adoption of the concaved plane formation, and for purposes of comparison the diagram, Fig. 24, shows the plane B of the same length and angle as the straight planes.

In examining the successive stream lines it will be found that while the 1st, 2d and 3d lines have a little less angle of impact than the corresponding lines in the straight plane, the last lines, 5, 6 and 7, have much greater angles, so that only line 4 strikes the plane at the same angle.

Such a plane structure would, therefore, have its center of pressure somewhere between the

lines 3 and 4, and the lift being thus, practically, uniform over the surface, would be more effective.

**THE CENTER OF PRESSURE.**—This is a term used to indicate the place on the plane where the air acts with the greatest force. It has reference to a point between the front and rear margins only of the plane.



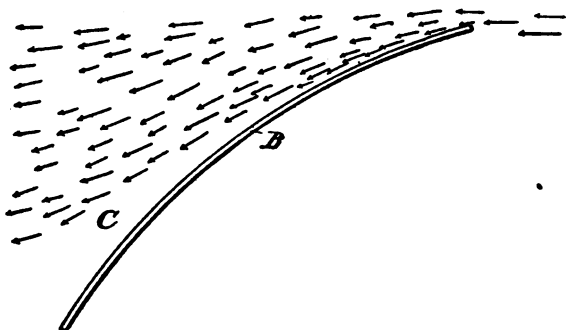
*Fig. 24. Air lines below a concaved Plane.*

**UTILIZING THE RAREFIED AREA.**—This structure, however, has another important advantage, as it utilizes the rarefied area which is produced, and which may be understood by reference to Fig. 25.

The plane B, with its upward curve, and at the same angle as the straight plane, has its lower end so curved, with relation to the forward movement, that the air, in rushing past the upper end, cannot follow the curve rapidly enough to maintain the same density along C, hence this exerts

an upward pull, due to the rarefied area, which serves as a lifting force, as well as the compressed mass beneath the plane.

**CHANGING CENTER OF PRESSURE.**—The center of pressure is not constant. It changes with the angle of the plane, but the range is considerably less on a concave surface than on a flat plane.



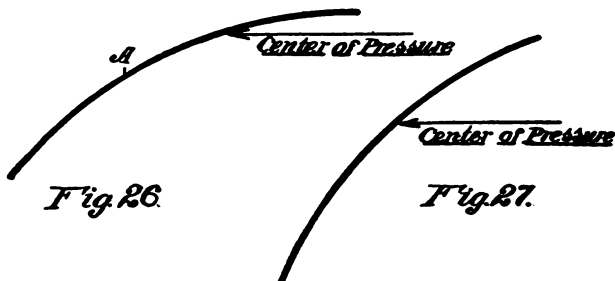
*Fig. 25. Air lines above a convex Plane.*

In a plane disposed at a small angle, A, as in Fig. 26, the center of pressure is nearer the forward end of the plane than with a greater positive angle of incidence, as in Fig. 27, and when the plane is in a normal flying angle, it is at the center, or at a point midway between the margins.

**PLANE MONSTROSITIES.**—Growing out of the idea that the wing in nature must be faithfully copied, it is believed by many that a plane with a pro-

nounced thickness at its forward margin is one of the secrets of bird flight.

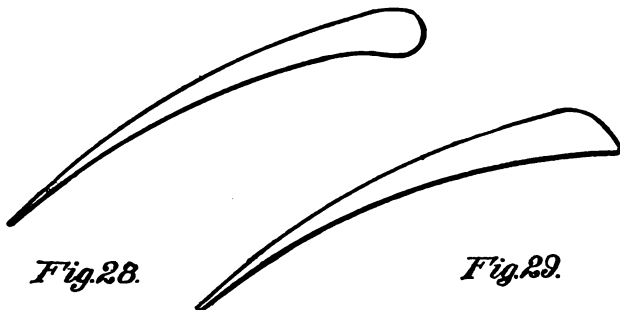
Accordingly certain inventors have designed



*Changing centers of Pressure*

types of wings which are shown in Figs. 28 and 29.

Both of these types have pronounced bulges, de-



*Bird-wing structures.*

signed to "split" the air, forgetting, apparently, that in other parts of the machine every effort is made to prevent head resistance.




**THE BIRD WING STRUCTURE.**—The advocates of such construction maintain that the forward edge of the plane must forcibly drive the air column apart, because the bird wing is so made, and that while it may not appear exactly logical, still there is something about it which seems to do the work, and for that reason it is largely adopted.

**WHY THE BIRD'S WING HAS A PRONOUNCED BULGE.**—Let us examine this claim. The bone which supports the entire wing surface, called the *pectoral*, has a heavy duty to perform. It is so constructed that it must withstand an extraordinary torsional strain, being located at the forward portion of the wing surface. *Torsion* has reference to a twisting motion.

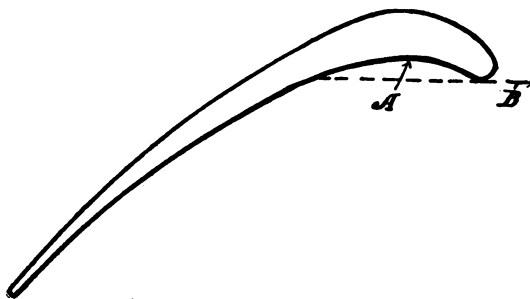
In some cases, as in the bat, this primary bone has an attachment to the rear of the main joint, where the rear margin of the wing is attached to the leg of the animal, thus giving it a support and the main bone is, therefore, relieved of this torsional stress.

**THE BAT'S WING.**—An examination of the bat's wing shows that the pectoral bone is very small and thin, thus proving that when the entire wing support is thrown upon the primary bone it must be large enough to enable it to carry out its functions. It is certainly not so made because it is a necessary shape which best adapts it for flying.



If such were the case then nature erred in the case of the bat, and it made a mistake in the housefly's wing which has no such anterior enlargement to assist (?) it in flying.

AN ABNORMAL SHAPE.—Another illustration is shown in Fig. 30, which has a deep concave directly behind the forward margin, as at A, so that when the plane is at an angle of about 22



*Fig. 30. One of the Monstrosities*

degrees, a horizontal line, as B, passing back from the nose, touches the incurved surface of the plane at a point about one-third of its measurement back across the plane.

This form is an exact copy of the wing of an actual bird, but it belongs, not to the soaring, but to the class which depends on flapping wings, and as such it cannot be understood why it should be used for soaring machines, as all aeroplanes are.

The foregoing instances of construction are cited to show how wildly the imagination will roam when it follows wrong ideals.

**THE TAIL AS A MONITOR.**—The tendency of the center of pressure to change necessitates a correctional means, which is supplied in the tail of the machine, just as the tail of a kite serves to hold it at a correct angle with respect to the wind and the pull of the supporting string.

## CHAPTER VII

### ABNORMAL FLYING STUNTS AND SPEEDS

“PEQUOD, a Frenchman, yesterday repeatedly performed the remarkable feat of flying with the machine upside down. This exhibition shows that the age of perfection has arrived in flying machines, and that stability is an accomplished fact.”—News item.

This is quoted to show how little the general public knows of the subject of aviation. It correctly represents the achievement of the aviator, and it probably voiced the sentiment of many scientific men, as well as of the great majority of aviators.

A few days afterwards, the same newspaper published the following:

“Lieutenant —, while experimenting yesterday morning, met his death by the overturning of his machine at an altitude of 300 meters. Death was instantaneous, and the machine was completely destroyed.”

The machines used by the two men were of the same manufacture, as Pequod used a stock machine which was strongly braced to support the inverted weight, but otherwise it was not unlike the well known type of monoplane.

Beachy has since repeated the experiment with a bi-plane, and it is a feat which has many imitators, and while those remarkable exhibitions are going on, one catastrophe follows the other with the same regularity as in the past.

Let us consider this phase of flying. Are they of any value, and wherein do they teach anything that may be utilized?

LACK OF IMPROVEMENTS IN MACHINES.—It is remarkable that not one single forward step has been taken to improve the type of flying machines for the past five years. They possess the same shape, their stabilizing qualities and mechanism for assuring stability are still the same.

MEN EXPLOITED, AND NOT THE MACHINE.—The fact is, that during this period the man has been exploited and not the machine. Men have learned, some few of them, to perform peculiar stunts, such as looping the loop, the side glide, the drop, and other features, which look, and are, hazardous, all of which pander to the sentiments of the spectators.

ABNORMAL FLYING OF NO VALUE.—It would be too broad an assertion to say that it has absolutely no value, because everything has its use in a certain sense, but if we are to judge from the progress of inventions in other directions, such exhibitions will not improve the art of building the device, or make a fool-proof machine.

Indeed, it is the very thing which serves as a deterrent, rather than an incentive. If machines can be handled in such a remarkable manner, they must be, indeed, perfect! Nothing more is needed! They must represent the highest structural type of mechanism!

That is the idea sought to be conveyed in the first paragraph quoted. It is pernicious, instead of praiseworthy, because it gives a false impression, and it is remarkable that even certain scientific journals have gravely discussed the perfected (?) type of flying machine as demonstrated by the experiments alluded to.

THE ART OF JUGGLING.—We may, occasionally, see a cyclist who understands the art of balancing so well that he can, with ease, ride a machine which has only a single wheel; or he can, with a stock bicycle, ride it in every conceivable attitude, and make it perform all sorts of feats.

It merely shows that man has become an ex-

pert at juggling with a machine, the same as he manipulates balls, and wheels, and other artifices, by his dexterity.

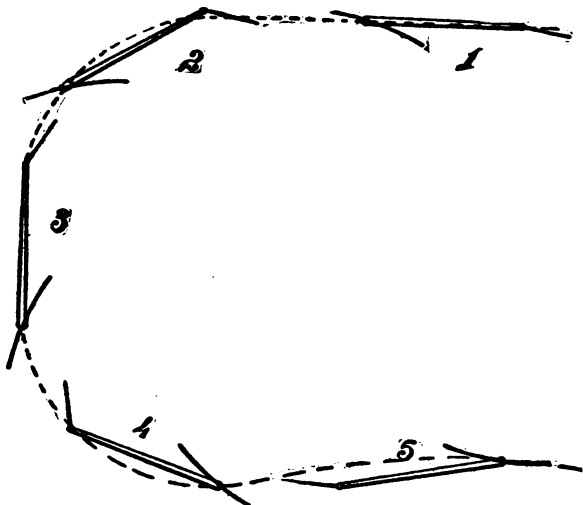
**PRACTICAL USES THE BEST TEST.**—The bicycle did not require such displays to bring it to perfection. It has been the history of every invention that improvements were brought about, not by abnormal experiments, but by practical uses and by normal developments.

The ability of an aviator to fly with the machine in an inverted position is no test of the machine's stability, nor does it in any manner prove that it is correctly built. It is simply and solely a juggling feat—something in the capacity of a certain man to perform, and attract attention because they are out of the ordinary.

**CONCAVED AND CONVEX PLANES.**—They were performed as exhibition features, and intended as such, and none of the exponents of that kind of flying have the effrontery to claim that they prove anything of value in the machine itself, except that it incidentally has destroyed the largely vaunted claim that concaved wings for supporting surfaces are necessary.

**HOW MOMENTUM IS A FACTOR IN INVERTED FLYING.**—When flying “upside down,” the convex side of the plane takes the pressure of the air, and maintains, so it is asserted, the weight of the

machine. This is true during that period when the loop is being made. The evolution is made by first darting down, as shown in Fig. 31, from the horizontal position, 1, to the position 2, where the turn begins.



*Fig. 31. Flying upside down.*

**THE TURNING MOVEMENT.**—Now note the characteristic angles of the tail, which is the controlling factor. In position 1 the tail is practically horizontal. In fact, in all machines, at high flight, the tail is elevated so as to give little positive angle of incidence to the supporting planes.



In position No. 2, the tail is turned to an angle of incidence to make the downward plunge, and when the machine has assumed the vertical, as in position 3, the tail is again reversed to assume the angle, as in 1, when flying horizontally.

At the lower turn, position 4, the tail is turned similar to the angle of position 2, which throws the rear end of the machine down, and as the horizontal line of flight is resumed, in an inverted position, as in position 4, the tail has the same angle, with relation to the frame, as the supporting planes.

During this evolution the engine is running, and the downward plunge develops a tremendous speed, and the great momentum thus acquired, together with the pulling power of the propeller while thus in flight, is sufficient to propel it along horizontally, whatever the plane surface curve, or formation may be.

It is the momentum which sustains it in space, not the air pressure beneath the wings, for reasons which we have heretofore explained. Flights of sufficient duration have thus been made to prove that convex, as well as concave surfaces are efficient; nevertheless, in its proper place we have given an exposition of the reasoning which led to the adoption of the concaved supporting surfaces.

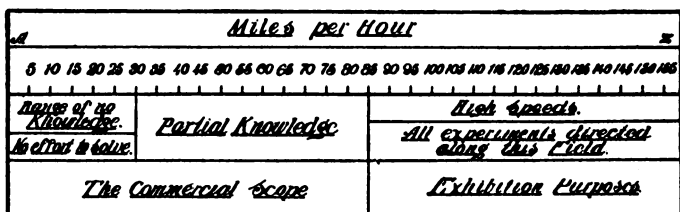
WHEN CONCAVED PLANES ARE DESIRABLE.—Unquestionably, for slow speeds the concaved wing is desirable, as will be explained, but for high speeds, surface formation has no value. That is shown by Pequod's feat.

THE SPEED MANIA.—This is a type of mania which pervades every field of activity in the building of aeroplanes. Speed contests are of more importance to the spectators on exhibition grounds than stability or durability. Builders pander to this, hence machines are built on lines which disregard every consideration of safety while at normal flight.

USES OF FLYING MACHINES.—The machine as now constructed is of little use commercially. Within certain limitations it is valuable for scouting purposes, and attempts have been made to use it commercially. But the unreliable character of its performances, due to the many elements which are necessary to its proper working, have operated against it.

PERFECTION IN MACHINES MUST COME BEFORE SPEED.—Contrary to every precept in the building of a new article, the attempt is made to make a machine with high speed, which, in the very nature of things, operates against its improvement. The opposite—lack of speed—is of far greater utility at this stage of its development.

**THE RANGE OF ITS USE.**—The subject might be illustrated by assuming that we have a line running from A to Z, which indicates the range of speeds in aeroplanes. The limits of speeds are fairly stated as being within thirty and eighty-five miles per hour. Less than thirty miles are impossible with any type of plane, and while some have made higher speeds than eighty-five miles it may be safe to assume that such flights took place under conditions where the wind contributed to the movement.



*Fig. 32. Chart showing Range of Uses*

**COMMERCIAL UTILITY.**—Before machines can be used successfully they must be able to attain slower speeds. Alighting is the danger factor. Speed machines are dangerous, not in flight or at high speeds, but when attempting to land. A large plane surface is incompatible with speed, which is another illustration that at high velocities supporting surfaces are not necessary.

Commercial uses require safety as the first ele-

ment, and reliability as the next essential. For passenger service there must be an assurance that it will not overturn, or that in landing danger is not ever-present. For the carrying of freight interrupted service will militate against it.

How few are the attempts to solve the problem of decreased speed, and what an eager, restless campaign is being waged to go faster and faster, and the addition of every mile above the record is hailed as another illustration of the perfection (?) of the flying machine.

To be able to navigate a machine at ten, or fifteen miles an hour, would scarcely be interesting enough to merit a paragraph; but such an accomplishment would be of far more value than all of Pequod's feats, and be more far-reaching in its effects than a flight of two hundred miles per hour.

## CHAPTER VIII

### KITES AND GLIDERS

**KITES** are of very ancient origin, and in China, Japan, and the Malayan Peninsula, they have been used for many years as toys, and for the purposes of exhibiting forms of men, animals, and particularly dragons, in their periodical displays.

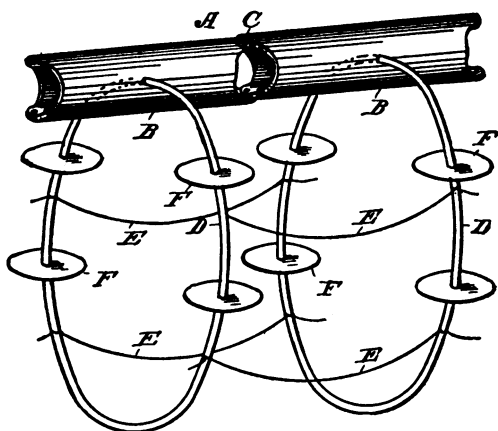
**THE DRAGON KITE.**—The most noted of all are the dragon kites, many of them over a hundred feet in length, are adapted to sail along majestically, their sinuous or snake-like motions lending an idea of reality to their gorgeously-colored appearance in flight.

**ITS CONSTRUCTION.**—It is very curiously wrought, and as it must be extremely light, bamboo and rattan are almost wholly used, together with rice paper, in its construction.

Fig. 33 shows one form of the arrangement, in which the bamboo rib, A, in which only two sections are shown, as B, B, form the backbone, and these sections are secured together with pivot pins C. Each section has attached thereto a hoop, or circularly-formed rib, D, the rib passing through the section B, and these ribs are con-

nected together loosely by cords E, which run from one to the other, as shown.

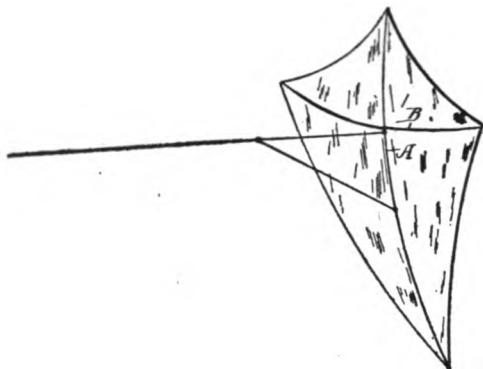
These circular ribs, D, are designed to carry a plurality of light paper disks, F, which are attached at intervals, and they are placed at such angles that they serve as small wing surfaces or aeroplanes to hold the structure in flight.



*Fig. 38. Ribs of Dragon Kite.*

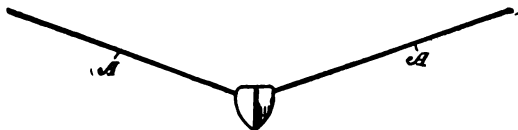
**THE MALAY KITE.**—The Malay kite, of which Fig. 34 shows the structure, is merely made up of two cross sticks, A, B, the vertical stick, A, being bent and rigid, whereas the cross stick, B, is light and yielding, so that when in flight it will bend, as shown, and as a result it has wonderful stability due to the dihedral angles of the two sur-

faces. This kite requires no tail to give it stability.



*Fig. 34. The Malay Kite.*

**DIHEDRAL ANGLES.**—This is a term to designate a form of disposing of the wings which has been found of great service in the single plane machines. A plane which is disposed at a rising



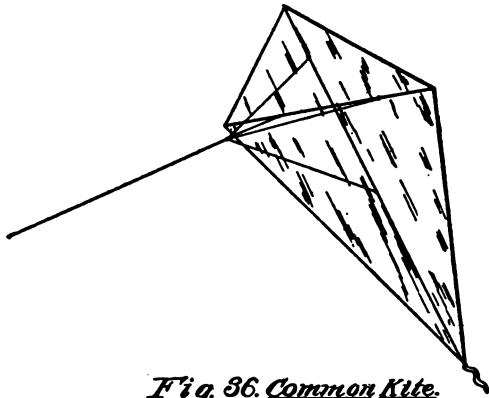
*Fig. 35. Dihedral Angle.*

angle, as A, A, Fig. 35, above the horizontal line, is called dihedral, or diedral.

This arrangement in monoplanes does away with the necessity of warping the planes, or chang-

ing them while in flight. If, however, the angle is too great, the wind from either quarter is liable to raise the side that is exposed.

**THE COMMON KITE.**—While the Malay kite has only two points of cord attachment, both along the vertical rib, the common kite, as shown in Fig. 36, has a four-point connection, to which the



*Fig. 36. Common Kite.*

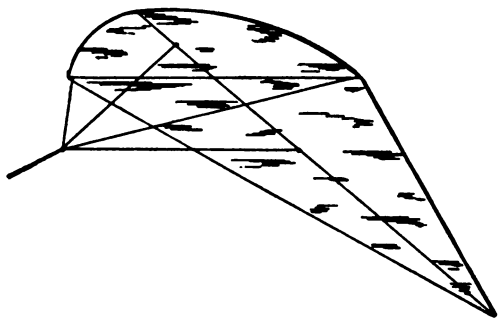
flying cord is attached. Since this form has no dihedral angle, it is necessary to supply a tail, which thus serves to keep it in equilibrium, while in flight.

Various modifications have grown out of the Malay kite. One of these forms, designed by Eddy, is exactly like the Malay structure, but instead of having a light flexible cross piece, it is bent to resemble a bow, so that it is rigidly held

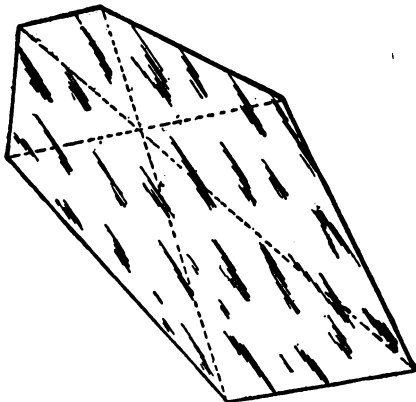


in a bent position, instead of permitting the wind to give it the dihedral angle.

THE BOW KITE.—Among the different types are



*Fig. 37. Bow Kite.*

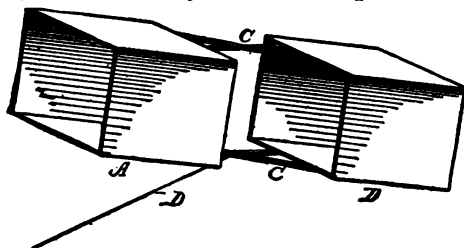


*Fig. 38. Hexagonal Kite.*

the bow kite, Fig. 37, and the hexagonal structure, Fig. 38, the latter form affording an especially large surface.

**THE BOX KITE.**—The most marked improvement in the form of kites was made by Hargreaves, in 1885, and called the *box kite*. It has wonderful stability, and its use, with certain modifications, in Weather Bureau experiments, have proven its value.

It is made in the form of two boxes, A, B, open at the ends, which are secured together by means of longitudinal bars, C, that extends from one to the other, so that they are held apart a distance,



*Fig. 39. Hargreaves Kite.*

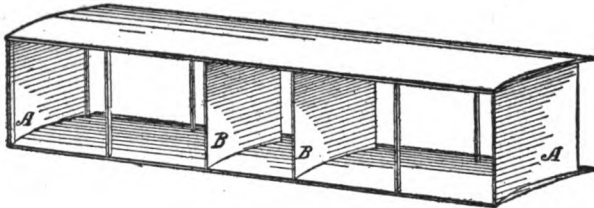
approximately, equal to the length of one of the boxes.

Their fore and aft stability is so perfect that the flying cord D is attached at one point only, and the sides of the boxes provide lateral stability to a marked degree.

**THE VOISON BIPLANE.**—This kind of kite furnished the suggestion for the Voison biplane, which was one of the earlier productions in flying machines.

Fig. 40 shows a perspective of the Voison plane, which has vertical planes A, A, at the ends, and also intermediate curtains B, B. This was found to be remarkably stable, but during its turning movements, or in high winds, was not satisfactory, and for that reason was finally abandoned.

LATERAL STABILITY IN KITES NOT CONCLUSIVE AS TO PLANES.—This is instanced to show that while such a form is admirably adapted for kite purposes, where vertical curtains are always in line

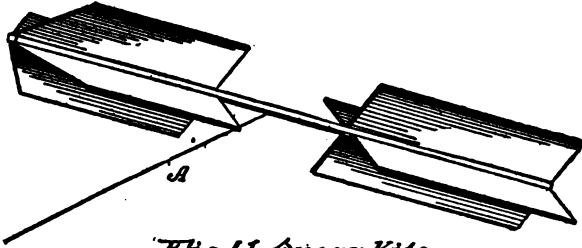


*Fig. 40. Voison Diplane.*

with the wind movement, and the structure is held taut by a cord, the lateral effect, when used on a machine which does not at all times move in line with the moving air current. A condition is thus set up which destroys the usefulness of the box kite formation.

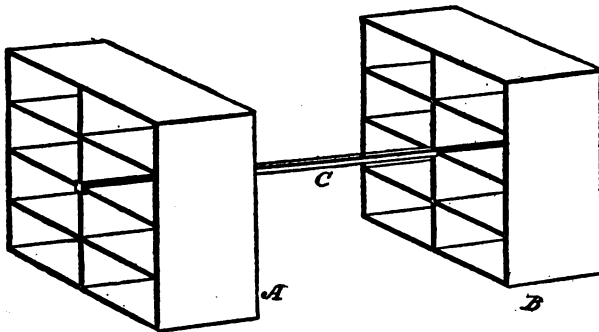
THE SPEAR KITE.—This is a novel kite, with remarkable steadiness and is usually made with the wings on the rear end larger than those on the forward end (Fig. 41), as thereby the cord

A can be attached to the spear midway between the two sets of wings.



*Fig. 41. Spear Kite.*

THE CELLULAR KITE.—Following out the suggestion of the Hargreaves kite, numerous forms embodying the principle of the box structure were made and put on the market before the aeroplane became a reality.



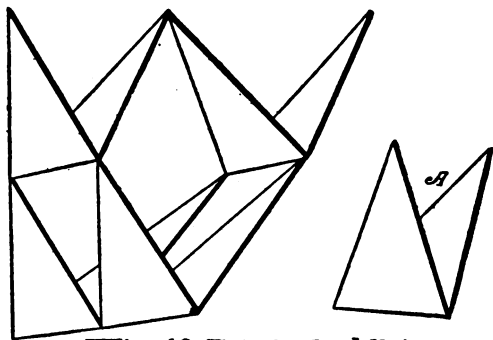
*Fig. 42. Cellular Kite.*

A structure of this form is illustrated in Fig. 42. Each box, as A, B, has therein a plurality of

vertical and horizontal partitions, so that a number of cells are provided, the two cell-like boxes being held apart by a bar C, axially arranged.

This type is remarkably stable, due to the small cells, and kites of this kind are largely used for making scientific experiments.

THE TETRAHEDRAL KITE.—Prof. Bell, inventor of the telephone, gave a great deal of study to



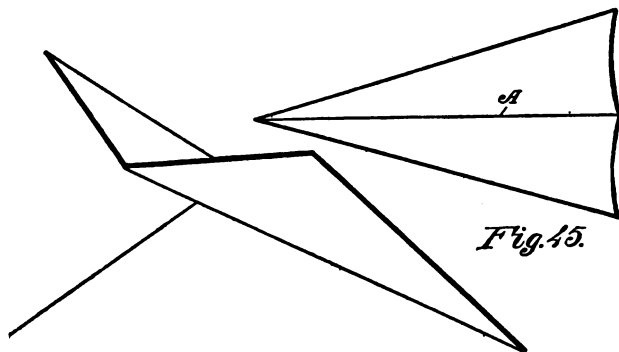
*Fig. 43. Tetrahedral Kite.*

kites, which resulted in the tetrahedral formation, as shown in Fig. 43.

The structure, apparently, is somewhat complicated, but an examination of a single pair of blades, as shown at A, shows that it is built up of triangularly-formed pieces, and that the openings between the pieces are equal to the latter, thereby providing a form of kite which possesses equilibrium to a great degree.

It has never been tried with power, and it is doubtful whether it would be successful as a sustaining surface for flying machines, for the same reasons that caused failure with the box-like formation of the Voison Machine.

THE DELTOID.—The deltoid is the simplest, and the most easily constructed of all the kites. It is usually made from stiff cardboard, A-shaped in



*Fig. 44. Deltoid Formation.*

outline, as shown in Figs. 44 and 45, and bent along a central line, as at A, forming two wings, each of which is a right-angled triangle.

The peculiarity of this formation is, that it has remarkable stability when used as a kite, with either end foremost. If a small weight is placed at the pointed end, and it is projected through the air, it will fly straight, and is but little affected by cross currents.

**THE DUNNE FLYING MACHINE.**—A top view of this biplane is shown in Fig. 46. The A-shaped disposition of the planes, gives it good lateral stability, but it has the disadvantage under which all aeroplanes labor, that the entire body of the machine must move on a fore and aft vertical plan in order to ascend or descend.



*Fig. 46. The Dunne bi-plane.*

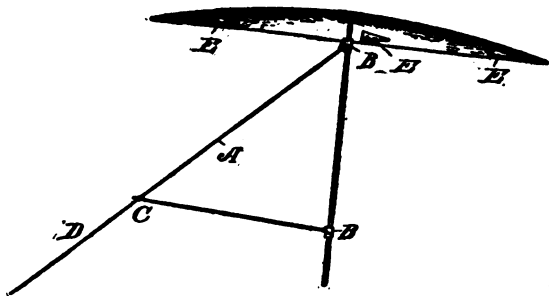
This is a true deltoid formation, as the angle of incidence of the planes is so disposed that when the planes are horizontal from end to end, the inclination is such as to make it similar to the deltoid kite referred to.

**ROTATING KITE.**—A type of kite unlike the others illustrated is a rotating structure, which gives great stability, due to the gyroscopic action on the supporting surfaces.

Fig. 47 shows a side view with the top in section. The supporting surface is umbrella-shaped. In fact, the ordinary umbrella will answer if not dished too much. An angularly-bent piece of wire

A, provided with loops B, B, at the ends, serve as bearings for the handle of the umbrella.

At the bend of the wire loop C, the cord D is attached. The lower side of the umbrella top has cup-shaped pockets E, near the margin, so arranged that their open ends project in the same direction, and the wind catching them rotates the circular plane.



*Fig. 47. Rotable Umbrella Kite.*

**KITE PRINCIPLES.**—A careful study of the examples here given, will impress the novice with one important fact, which, in its effect has a more important bearing on successful flight, than all the bird study and speculations concerning its mysteries.

This fact, in essence, is, that the angle of the kite is the great factor in flight next to the power necessary to hold it. Aside from this, the com-



parison between kites and aeroplanes is of no practical value.

Disregarding the element of momentum, the drift of a machine against a wind, is the same, dynamically, as a plane at rest with the wind moving past it. But there is this pronounced difference: The cord which supports the kite holds it so that the power is in one direction only.

When a side gust of wind strikes the kite it is moved laterally, in sympathy with the kite, hence the problem of lateral displacement is not the same as with the aeroplane.

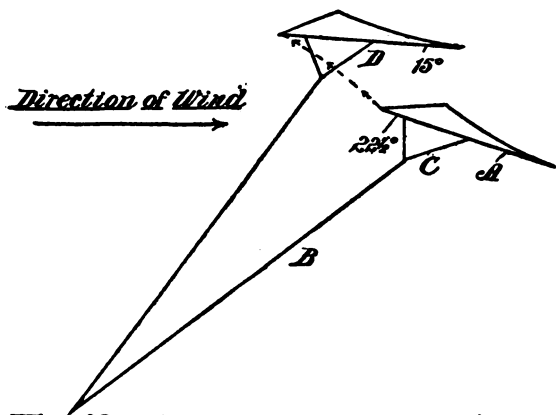
**LATERAL STABILITY IN KITES.**—In the latter the power is definitely fixed with relation to the machine itself, and if we should assume that a plane with a power on it sufficient to maintain a flight of 40 miles an hour, should meet a wind moving at the same speed, the machine would be stationary in space.

Such a condition would be the same, so far as the angles of the planes are concerned, with a kite held by a string, but there all similarity in action ends.

The stabilizing quality of the kite may be perfect, as the wind varies from side to side, but the aeroplane, being free, moves to the right or to the left, and does not adjust itself by means of a fixed point, but by a movable one.

SIMILARITY OF FORE AND AFT CONTROL.—Fore and aft, however, the kite and aeroplane act the same. Fig. 48 shows a diagram which illustrates the forces which act on the kite, and by means of which it adjusts its angle automatically.

Let us assume that the kite A is flown from a cord B, so that its angle is  $22\frac{1}{2}$  degrees, the



*Fig. 48. Action of wind forces on Kite.*

wind being 15 miles per hour to maintain the cord B at that angle. When the wind increases to 20 miles an hour there is a correspondingly greater lift against the kite.

As its angle is fixed by means of the loop C, it cannot change its angle with reference to the cord, or independently of it, and its only course is to move up higher and assume the position

shown by the figure at D, and the angle of incidence of the kite is therefore changed to 15 degrees, or even to 10 degrees.

In the case of the aeroplane the effect is similar from the standpoint of power and disposition of the planes. If it has sufficient power, and the angle of the planes is not changed, it will ascend; if the planes are changed to 15 degrees to correspond with the kite angle it will remain stationary.

**GLIDING FLIGHT.**—The earliest attempt to fly by gliding is attributed to Oliver, a Monk of Malmesbury who, in 1065 prepared artificial wings, and with them jumped from a tower, being injured in the experiment.

Nearly 700 years later, in 1801, Resnier, a Frenchman, conducted experiments with varying results, followed by Berblinger, in 1842, and LeBris, a French sailor, in 1856.

In 1884, J. J. Montgomery, of California, designed a successful glider, and in 1889 Otto and Gustav Lilienthal made the most extended tests, in Germany, and became experts in handling gliders.

Pilcher, in England, was the next to take up the subject, and in 1893 made many successful glides, all of the foregoing machines being single plane surfaces, similar to the monoplane.

Long prior to 1896 Octave Chanute, an en-

gineer, gave the subject much study, and in that year made many remarkable flights, developing the double plane, now known as the biplane.

He was an ardent believer in the ability of man to fly by soaring means, and without using power for the purpose.

It is doubtful whether gliders contributed much to the art in the direction of laterally stabilizing aeroplanes. They taught useful lessons with respect to area and fore and aft control.

The kite gave the first impulse to seek out a means for giving equilibrium to planes, and Montgomery made a kite with warping wings as early as 1884.

Penaud, a Frenchman, in 1872, made a model aeroplane which had the stabilizing means in the tail. All these grew out of kite experiments; and all gliders followed the kite construction, or the principles involved in them, so that, really, there is but one intervening step between the kite and the flying machine, as we know it, the latter being merely kites with power attached, as substitutes for the cords.

ONE OF THE USES OF GLIDER EXPERIMENTS.—  
There is one direction in which gliders are valuable to the boy and to the novice who are interested in aviation. He may spend a lifetime in gliding and not advance in the art. It is ques-

tionable whether in a scientific way it will be of any service to him; but experiments of this character give confidence, the ability to quickly grasp a situation, and it will thus teach self reliance in emergencies.

When in a glider quick thinking is necessary. The ability to shift from one position to another; to apply the weight where required instantaneously; to be able during the brief exciting moment of flight to know just what to do, requires alertness.

Some are so wedded to the earth that slight elevation disturbs them. The sensation in a glider while in flight is unlike any other experience. It is like riding a lot of tense springs, and the exhilaration in gliding down the side of a hill, with the feet free and body suspended, is quite different from riding in an aeroplane with power attached.

HINTS IN GLIDING.—It seems to be a difficult matter to give any advice in the art of gliding. It is a feat which seems to necessitate experiment from first to last. During the hundreds of tests personally made, and after witnessing thousands of attempts, there seems to be only a few suggestions or possible directions in which caution might be offered.

First, in respect to the position of the body at

the moment of launching. The glider is usually so made that in carrying it, preparatory to making the run and the leap required to glide, it is held so that it balances in the hands.

Now the center of air pressure in gliding may not be at the same point as its sustaining weight when held by the hand, and furthermore, as the arm-pits, by which the body of the experimenter are held while gliding, are not at the same point, but to the rear of the hands, the moment the glider is launched too great a weight is brought to the rear margin of the planes, hence its forward end lifts up.

This condition will soon manifest itself, and be corrected by the experimenter; but there is another difficulty which is not so easy to discover and so quick to remedy, and that is the swing of the legs the moment the operator leaves the ground.

The experimenter learns, after many attempts, that gliding is a matter of a few feet only, and he anticipates landing too soon, and the moment he leaps from the ground the legs are swung forwardly ready to alight.

This is done unconsciously, just as a jumper swings his legs forwardly in the act of alighting. Such a motion naturally disturbs the fore and aft stability of the gliding machine, by tilting up the

forward margin, and it banks against the air, instead of gliding.

The constant fear of all gliders is, that the machine will point downwardly, and his motion, as well as the position of the body, tend to shoot it upwardly, instead.

## CHAPTER IX

### AEROPLANE CONSTRUCTION

As may be inferred from the foregoing statements, there are no definite rules for the construction of either type of flying machine, as the flying models vary to such an extent that it is difficult to take either of them as a model to represent the preferred type of construction.

**LATERAL, AND FORE AND AFT.**—The term *lateral* should be understood, as applied to aeroplanes. It is always used to designate the direction at right angles to the movement of the machine. *Fore and aft* is a marine term meaning *lengthwise*, or from front to rear, hence is always at right angles to the lateral direction.

The term *transverse* is equivalent to lateral, in flying machine parlance, but there is this distinction: *Transverse* has reference to a machine or object which, like the main planes of an aeroplane, are broader, (that is,—from end to end) than their length, (from front to rear).

On the other hand, lateral has reference to side branches, as, for instance, the monoplane wings,



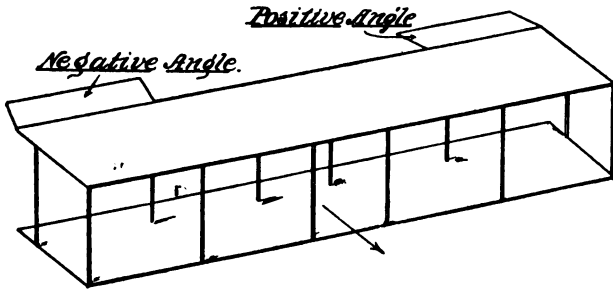
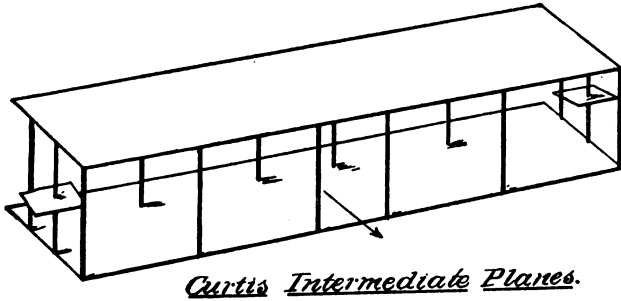
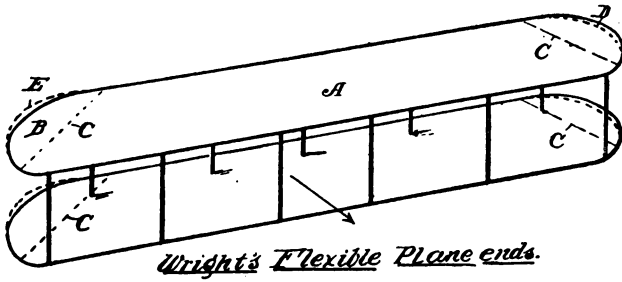
which branch out from the sides of the fore and aft body.

**STABILITY AND STABILIZATION.**—These terms constantly appear in describing machines and their operations. If the flying structure, whatever it may be, has means whereby it is kept from rocking from side to side, it has stability, which is usually designated as *lateral stability*. The mechanism for doing this is called a *stabilizer*.

**THE WRIGHT SYSTEM.**—The Wright machine has reference solely to the matter of laterally controlling the flying structure, and does not pertain to the form or shape of the planes.

In Fig. 49 A designates the upper and lower planes of a Wright machine, with the peculiar rounded ends. The ends of the planes are so arranged that the rear margins may be raised or lowered, independently of the other portions of the planes, which are rigid. This movement is indicated in sketch 1, where the movable part B is, as we might say, hinged along the line C.

The dotted line D on the right hand end, shows how the section is depressed, while the dotted lines E at the left hand end shows the section raised. It is obvious that the downturned ends, as at D, will give a positive angle at one end of the planes, and the upturned wings E at the other end will give a negative angle, and thus cause the right



Farman Ailerons.  
*Fig. 49.*

hand end to raise, and the other end to move downwardly, as the machine moves forwardly through the air.

**CONTROLLING THE WARPING ENDS.**—Originally the Wrights controlled these warping sections by means of a cradle occupied by the aviator, so that the cradle would move or rock, dependent on the tilt of the machine. This was what was termed *automatic* control. This was found to be unsatisfactory, and the control has now been placed so that it connects with a lever and is operated by the aviator, and is called *Manually-operated* control.

In all forms of control the wings on one side are depressed on one side and correspondingly elevated on the other.

**THE CURTIS WINGS.**—Curtis has small wings, or ailerons, intermediate the supporting surfaces, and at their extremities, as shown in sketch 2. These are controlled by a shoulder rack or swinging frame operated by the driver, so that the body in swinging laterally will change the two wings at the same time, but with angles in different directions.

**THE FARMAN AILERONS.**—Farman's disposition is somewhat different, as shown in sketch 3. The wings are hinged to the upper planes at their rear edges, and near the extremities of the planes.

Operating wires lead to a lever within reach of the aviator, and, by this means, the wings are held at any desired angle, or changed at will.

The difficulty of using any particular model, is true, also, of the arrangement of the fore and aft control, as well as the means for laterally stabilizing it. In view of this we shall submit a general form, which may be departed from at will.

**FEATURES WELL DEVELOPED.**—Certain features are fairly well developed, however. One is the angle of the supporting plane, with reference to the frame itself; and the other is the height at which the tail and rudder should be placed above the surface of the ground when the machine is at rest.

**DEPRESSING THE REAR END.**—This latter is a matter which must be taken into consideration, because in initiating flight the rear end of the frame is depressed in order to give a sufficient angle to the supporting planes so as to be able to inaugurate flight.

In order to commence building we should have some definite idea with respect to the power, as this will, in a measure, determine the area of the supporting surfaces, as a whole, and from this the sizes of the different planes may be determined.

**DETERMINING THE SIZE.**—Suppose we decide on 300 square feet of sustaining surface. This may

require a 30, a 40 or a 50 horse power motor, dependent on the speed required, and much higher power has been used on that area.

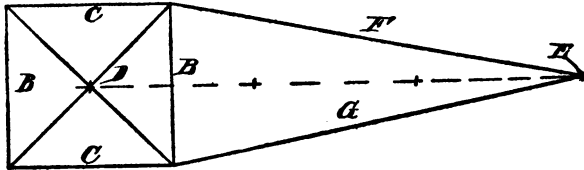
However, let us assume that a forty horse power motor is available, our 300 square feet of surface may be put into two planes, each having 150 square feet of surface, which would make each 5' by 30' in size; or, it may be decided to make the planes narrower, and proportionally longer. This is immaterial. The shorter the planes transversely, the greater will be the stability, and the wider the planes the less will be the lift, comparatively.

**RULE FOR PLACING THE PLANES.**—The rule for placing the planes is to place them apart a distance equal to the width of the planes themselves, so that if we decide on making them five feet wide, they should be placed at least five feet apart. This rule, while it is an admirable one for slow movements or when starting flight, is not of any advantage while in rapid flight.

If the machine is made with front and rear horizontally-disposed rudders, or elevators, they also serve as sustaining surfaces, which, for the present will be disregarded.

Lay off a square A, Fig. 49a, in which the vertical lines B, B, and the horizontal lines C, C, are 5' long, and draw a cross D within this, the lines running diagonally from the corners.

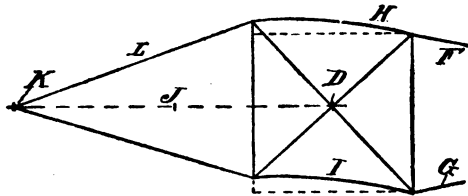
Now step off from the center cross line D, three spaces, each five feet long, to a point E, and join this point by means of upper and lower bars F,



*Fig. 19. Rule for Spacing Planes.*

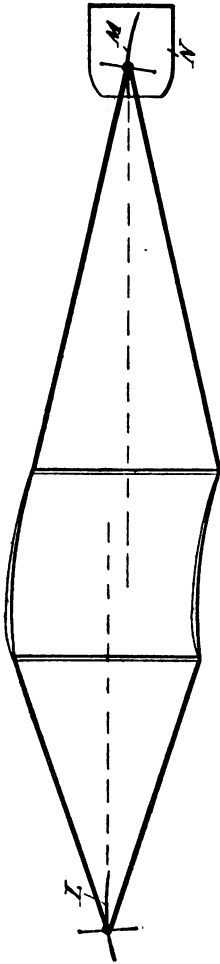
G, with the upper and lower planes, so as to form the tail frame.

As shown in Fig. 50, the planes should now be indicated, and placed at an angle of about 8 degrees angle, which are illustrated, H being the

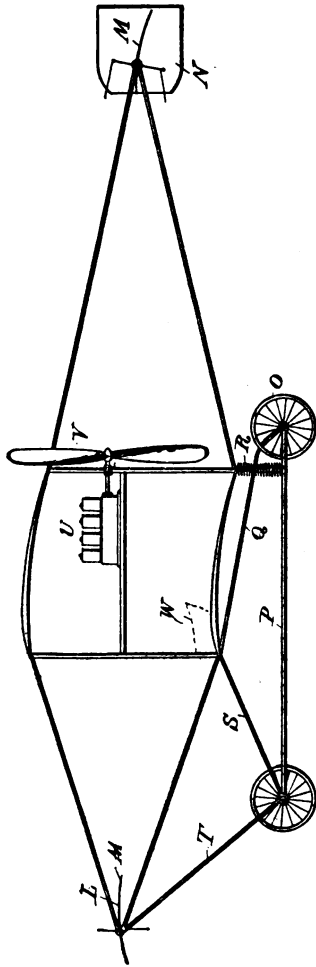


*Fig. 50. Frame of Control Planes.*

upper and I the lower plane. Midway between the forward edges of the two planes, is a horizontal line J, extending forwardly, and by stepping off the width of two planes, a point K is made, which forms the apex of a frame L, the rear ends of the



*Fig. 51. Side Elevation of Frame.*



*Fig. 52. Frame with Running Gear.*

bars being attached to the respective planes H, I, at their forward edges.

**ELEVATING PLANES.**—We must now have the general side elevation of the frame, the planes, their angles, the tail and the rudder support, and the frame for the forward elevator.

To this may be added the forward elevating plane L, the rear elevator, or tail M, and the vertical steering rudder N.

The frame which supports the structure thus described, may be made in a variety of ways, the object being to provide a resilient connection for the rear wheel O.

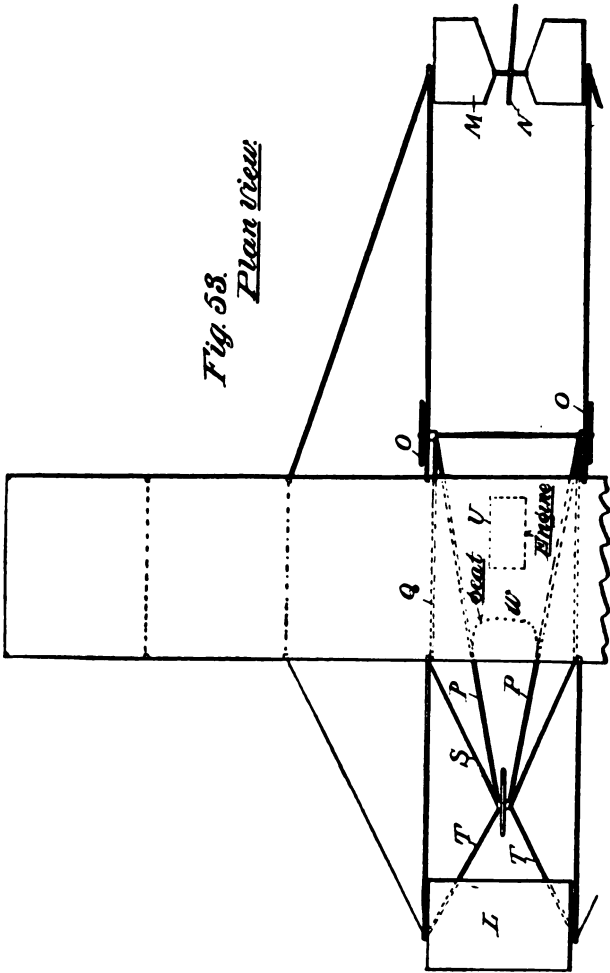
Fig. 52 shows a frame which is simple in construction and easily attached. The lower fore and aft side bars P have the single front wheel axle at the forward end, and the aft double wheels at the rear end, a flexible bar Q, running from the rear wheel axle to the forward end of the lower plane.

A compression spring R is also mounted between the bar and rear end of the lower plane to take the shock of landing. The forward end of the bar P has a brace S extending up to the front edge of the lower plane, and another brace T connects the bars P, S, with the end of the forwardly-projecting frame.

The full page view, Fig. 53, represents a plan

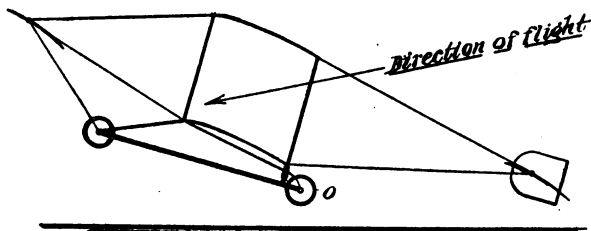


*Fig. 58. Plan view.*



view, with one of the wings cut away, showing the general arrangement of the frame, and the three wheels required for support, together with the brace bars referred to.

The necessity of the rear end elevation will now be referred to. The tail need not, necessarily, be located at a point on a horizontal line between the planes. It may be higher, or lower than the planes, but it should not be in a position



*Fig. 54. Alighting.*

to touch the ground when the machine is about to ascend.

The angle of ascension in the planes need not exceed 25 degrees so the frame does not require an angle of more than 17 degrees. This is shown in Fig. 54, where the machine is in a position ready to take the air at that angle, leaving ample room for the steering rudder.

**ACTION IN ALIGHTING.**—Also, in alighting, the machine is banked, practically in the same posi-

tion thus shown, so that it alights on the rear wheels O.

The motor U is usually mounted so its shaft is midway between the planes, the propeller V being connected directly with the shaft, and being behind the planes, is on a medial line with the machine.

The control planes L, M, N, are all connected up by means of flexible wires with the aviator at the set W, the attachments being of such a character that their arrangement will readily suggest themselves to the novice.

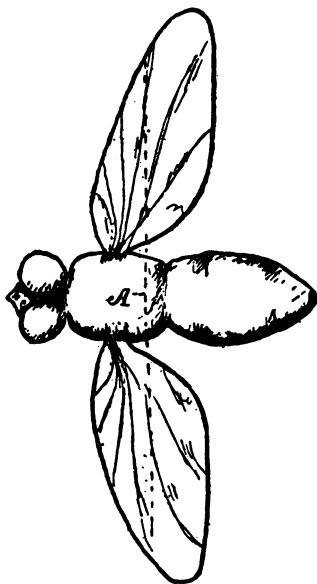
**THE MONOPLANE.**—From a spectacular standpoint a monoplane is the ideal flying machine. It is graceful in outline, and from the fact that it closely approaches the form of the natural flyer, seems to be best adapted as a type, compared with the biplane.

**THE COMMON FLY.**—So many birds have been cited in support of the various flying theories that the house fly, as an example has been disregarded. We are prone to overlook the small insect, but it is, nevertheless, a sample which is just as potent to show the efficiency of wing surface as the condor or the vulture.

The fly has greater mobility than any other flying creature. By the combined action of its legs and wings it can spring eighteen inches in the

tenth of a second; and when in flight can change its course instantaneously.

If a sparrow had the same dexterity, proportionally, it could make a flight of 800 feet in the same time. The posterior legs of the fly are the



*Fig. 55. Common Fly. Outstretched Wings.*

same length as its body, which enable it to spring from its perch with amazing facility.

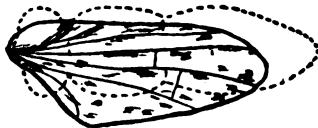
The wing surface, proportioned to its body and weight, is no less a matter for wonder and consideration.

In Fig. 55 is shown the outlines of the fly with outstretched wings. Fig. 56 represents it with the wing folded, and Fig. 57 is a view of a wing with the relative size of the top of the body shown in dotted lines.



*Fig. 56. Common Fly. Folded Wings*

The first thing that must attract attention, after a careful study is the relative size of the body and wing surface. Each wing is slightly smaller than the upper surface of the body, and the thickness of the body is equal to each wing spread.



*Fig. 57. Relative size of wings and body.*

The weight, compared with sustaining surface, if expressed in understandable terms, would be equal to sixty pounds for every square foot of surface.

**STREAM LINES.**—The next observation is, that what are called *stream lines* do not exist in the fly. Its head is as large in cross section as its body,

with the slightest suggestion only, of a pointed end. Its wings are perfectly flat, forming a true plane, not dished, or provided with a *cambre*, even, that upward curve, or bulge on the top of the aeroplane surface, which seems to possess such a fascination for many *bird flight* advocates.

It will also be observed that the wing connection with the body is forward of the line A, which represents the point at which the body will balance itself, and this line passes through the wings so that there is an equal amount of supporting surface fore and aft of the line.

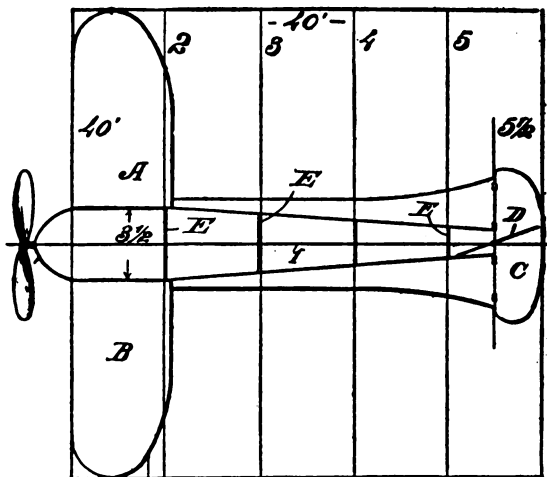
Again, the wing attachment is at the upper side of the body, and the vertical dimension of the body, or its thickness, is equal to four-fifths of the length of the wing.

The wing socket permits a motion similar to a universal joint, Fig. 55 showing how the inner end of the wing has a downward bend where it joins the back, as at B.

**THE MONOPLANE FORM.**—For the purpose of making comparisons the illustrations of the monoplane show a machine of 300 square feet of surface, which necessitates a wing spread of forty feet from tip to tip, so that the general dimensions of each should be  $18\frac{1}{2}$  feet by  $8\frac{1}{2}$  feet at its widest point.

First draw a square forty feet each way, as in

Fig. 58, and through this make a horizontal line 1, and four intermediate vertical lines are then drawn, as 2, 3, 4, 5, thus providing five divisions, each eight feet wide. In the first division the planes A, B, are placed, and the tail, or elevator C, is one-half the width of the last division.



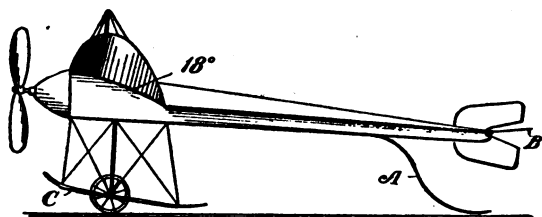
*Fig. 58. Plan of Monoplane.*

The frame is  $3\frac{1}{2}$  feet wide at its forward end, and tapers down to a point at its rear end, where the vertical control plane D is hinged, and the cross struts E, E, are placed at the division lines 3, 4, 5.

The angles of the planes, with relation to the frame, are usually greater than in the biplane,

for the reason that the long tail plane requires a greater angle to be given to the planes when arising; or, instead of this, the planes A, B, are mounted high enough to permit of sufficient angle for initiating flight without injuring the tail D.

Some monoplanes are built so they have a support on wheels placed fore and aft. In others the tail is supported by curved skids, as shown at A, Fig. 59, in which case the forward support-



*Fig. 59. Side Elevation, Monoplane.*

ing wheels are located directly beneath the planes.

As the planes are at about eighteen degrees angle, relative to the frame, and the tail plane B is at a slight negative angle of incidence, as shown at the time when the engine is started, the air rushing back from the propeller, elevates the tail, and as the machine moves forwardly over the ground, the tail raises still higher, so as to give a less angle of incidence to the planes while skimming along the surface of the ground.

In order to mount, the tail is suddenly turned



to assume a sharp negative angle, thus swinging the tail downwardly, and this increases the angle of planes to such an extent that the machine leaves the ground, after which the tail is brought to the proper angle to assure horizontal flight.

The drawing shows a skid at the forward end, attached to the frame which carries the wheels. The wheels are mounted beneath springs so that when the machine alights the springs yield sufficiently to permit the skids to strike the ground, and they, therefore, act as brakes, to prevent the machine from traveling too far.

## CHAPTER X

### POWER AND ITS APPLICATION

THIS is a phase of the flying machine which has the greatest interest to the boy. He instinctively sees the direction in which the machine has its life,—its moving principle. Planes have their fascination, and propellers their mysterious elements, but power is the great and absorbing question with him.

We shall try to make its application plain in the following pages. We have nothing to do here with the construction and operation of the motor itself, as, to do that justice, would require pages.

**FEATURES IN POWER APPLICATION.**—It will be more directly to the point to consider the following features of the power and its application:

1. The amount of power necessary.
2. How to calculate the power applied.
3. Its mounting.

**WHAT AMOUNT OF POWER IS NECESSARY.**—In the consideration of any power plant certain calculations must be made to determine what is required. A horse power means the lifting of a certain

weight, a definite distance, within a specified time.

If the weight of the vehicle, with its load, are known, and its resistance, or the character of the roadway is understood, it is a comparatively easy matter to calculate just how much power must be exerted to overcome that resistance, and move the vehicle a certain speed.

In a flying machine the same thing is true, but while these problems may be known in a general way, the aviator has several unknown elements ever present, which make estimates difficult to solve.

**THE PULL OF THE PROPELLER.**—Two such factors are ever present. The first is the propeller pull. The energy of a motor, when put into a propeller, gives a pull of less than eight pounds for every horse power exerted.

**FOOT POUNDS.**—The work produced by a motor is calculated in *Foot Pounds*. If 550 pounds should be lifted, or pulled, one foot in one second of time, it would be equal to *one horse power*.

But here we have a case where one horse power pulls only eight pounds, a distance of one foot within one second of time, and we have utilized less than one sixty-fifth of the actual energy produced.

**SMALL AMOUNT OF POWER AVAILABLE.**—This is

due to two things: First, the exceeding lightness of the air, and its great elasticity; and, second, the difficulty of making a surface which, when it strikes the air, will get a sufficient grip to effect a proper pull.

Now it must be obvious, that where only such a small amount of energy can be made available, in a medium as elusive as air, the least change, or form, of the propeller, must have an important bearing in the general results.

**HIGH PROPELLER SPEED IMPORTANT.**—Furthermore, all things considered, high speed is important in the rotation of the propeller, up to a certain point, beyond which the pull decreases in proportion to the speed. High speed makes a vacuum behind the blade and thus decreases the effective pull of the succeeding blade.

**WIDTH AND PITCH OF BLADES.**—If the blade is too wide the speed of the engine is cut down to a point where it cannot exert the proper energy; if the pitch is very small then it must turn further to get the same thrust, so that the relation of diameter, pitch and speed, are three problems far from being solved.

It may be a question whether the propeller form, as we now know it, is anything like the true or ultimate shape, which will some day be discovered.

**EFFECT OF INCREASING PROPELLER PULL.**—If the present pull could be doubled what a wonderful revolution would take place in aerial navigation, and if it were possible to get only a quarter of the effective pull of an engine, the results would be so stupendous that the present method of flying would seem like child's play in comparison.

It is in this very matter,—the application of the power, that the bird, and other flying creatures so far excel what man has done. Calculations made with birds as samples, show that many of them are able to fly with such a small amount of power that, if the same energy should be applied to a flying machine, it would scarcely drive it along the ground.

**DISPOSITION OF THE PLANES.**—The second factor is the disposition or arrangement of the planes with relation to the weight. Let us illustrate this with a concrete example:

We have an aeroplane with a sustaining surface of 300 square feet which weighs 900 pounds, or 30 pounds per square foot of surface.

**DIFFERENT SPEEDS WITH SAME POWER.**—Now, we may be able to do two things with an airship under those conditions. It may be propelled through the air thirty miles an hour, or sixty miles, with the expenditure of the same power.

An automobile, if propelled at sixty, instead of

thirty miles an hour, would require an additional power in doing so, but an airship acts differently, within certain limitations.

When it is first set in motion its effective pull may not be equal to four pounds for each horse power, due to the slow speed of the propeller, and also owing to the great angle of incidence which resists the forward movement of the ship.

INCREASE OF SPEED ADDS TO RESISTANCE.—Finally, as speed increases, the angle of the planes decrease, resistance is less, and up to a certain point the pull of the propeller increases; but beyond that the vacuum behind the blades becomes so great as to bring down the pull, and there is thus a balance,—a sort of mutual governing motion which, together, determine the ultimate speed of the aeroplane.

HOW POWER DECREASES WITH SPEED.—If now, with the same propeller, the speed should be doubled, the ship would go no faster, because the bite of the propeller on the air would be ineffective, hence it will be seen that it is not the amount of power in itself, that determines the speed, but the shape of the propeller, which must be so made that it will be most effective at the speed required for the ship.

While that is true when speed is the matter of greatest importance, it is not the case where it is

desired to effect a launching. In that case the propeller must be made so that its greatest pull will be at a slow speed. This means a wider blade, and a greater pitch, and a comparatively greater pull at a slow speed.

No such consideration need be given to an automobile. The constant accretion of power adds to its speed. In flying machines the aviator must always consider some companion factor which must be consulted.

HOW TO CALCULATE THE POWER APPLIED.—In a previous chapter reference was made to a plane at an angle of forty-five degrees, to which two scales were attached, one to get its horizontal pull, or drift, and the other its vertical pull, or lift.

PULLING AGAINST AN ANGLE.—Let us take the same example in our aeroplane. Assuming that it weighs 900 pounds, and that the angle of the planes is forty-five degrees. If we suppose that the air beneath the plane is a solid, and frictionless, and a pair of scales should draw it up the incline, the pull in doing so would be one-half of its weight, or 450 pounds.

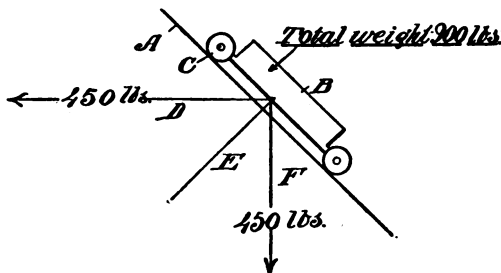
It must be obvious, therefore, that its force, in moving downwardly, along the surface A, Fig. 60, would be 450 pounds.

The incline thus shown has thereon a weight B, mounted on wheels C, and the forwardly-project-

ing cord represents the power, or propeller pull, which must, therefore, exert a force of 450 pounds to keep it in a stationary position against the surface A.

In such a case the thrust along the diagonal line E would be 900 pounds, being the composition of the two forces pulling along the lines D, F.

THE HORIZONTAL AND VERTICAL PULL.—Now it must be obvious, that if the incline takes half of



*Fig. 60. Horizontal and vertical pull.*

the weight while it is being drawn forwardly, in the line of D, if we had a propeller drawing along that line, which has a pull of 450 pounds, it would maintain the plane in flight, or, at any rate hold it in space, assuming that the air should be moving past the plane.

The table of *lift and drift* gives a fairly accurate method of determining this factor, and we refer to the chapter on that subject which will show the manner of making the calculations.



**THE POWER MOUNTING.**—More time and labor has been wasted, in airship experiments, in poor motor mounting, than in any other direction. This is especially true where two propellers are used, or where the construction is such that the propeller is mounted some distance from the motor.

**SECURING THE PROPELLER TO THE SHAFT.**—But even where the propeller is mounted on the engine shaft, too little care is exercised to fix it securely. The vibratory character of the mounting makes this a matter of first importance. If there is a solid base a poorly fixed propeller will hold much longer, but it is the extreme vibration that causes the propeller fastening to give way.

**VIBRATIONS.**—If experimenters realized that an insecure, shaking, or weaving bed would cause a loss of from ten to fifteen per cent. in the pull of the propeller, more care and attention would be given to this part of the structure.

**WEAKNESSES IN MOUNTING.**—The general weaknesses to which attention should be directed are, first, the insecure attachment of the propeller to the shaft; second, the liability of the base to weave; or permit of a torsional movement; third, improper bracing of the base to the main body of the aeroplane.

If the power is transferred from the cylinder

to the engine shaft where it could deliver its output without the use of a propeller, it would not be so important to consider the matter of vibration; but the propeller, if permitted to vibrate, or dance about, absorbs a vast amount of energy, while at the same time cutting down its effective pull.

Aside from this it is dangerous to permit the slightest displacement while the engine is running. Any looseness is sure to grow worse, instead of better, and many accidents have been registered by bolts which have come loose from excessive vibration. It is well, therefore, to have each individual nut secured, or properly locked, which is a matter easily done, and when so secured there is but little trouble in going over the machine to notice just how much more the nut must be taken up to again make it secure.

**THE GASOLINE TANK.**—What horrid details have been told of the pilots who have been burned to death with the escaping gasoline after an accident, before help arrived. There is no excuse for such dangers. Most of such accidents were due to the old practice of making the tanks of exceedingly light or thin material, so that the least undue jar would tear a hole at the fastening points, and thus permit the gasoline to escape.

A thick copper tank is by far the safest, as this

metal will not readily rupture by the wrench which is likely in landing.

**WHERE TO LOCATE THE TANK.**—There has been considerable discussion as to the proper place to locate the tank. Those who advocate its placement overhead argue that in case of an accident the aeroplane is likely to overturn, and the tank will, therefore, be below the pilot. Those who believe it should be placed below, claim that in case of overturning it is safer to have the tank afire above than below.

**DANGER TO THE PILOT.**—The great danger to the pilot, in all cases of accidents, lies in the overturning of the machine. Many have had accidents where the machine landed right side up, even where the fall was from a great height, and the only damage to the aviator was bruises. Few, if any, pilots have escaped where the machine has overturned.

It is far better, in case the tank is light, to have it detached from its position, when the ship strikes the earth, because in doing so, it will not be so likely to burn the imprisoned aviator.

In all cases the tank should be kept as far away from the engine as possible. There is no reason why it cannot be placed toward the tail end of the machine, a place of safety for two reasons: First, it is out of the reach of any possible dan-

ger from fire; and, second, the accidents in the past show that the tail frame is the least likely to be injured.

In looking over the illustrations taken from the accidents, notice how few of the tails are even disarranged, and in many of them, while the entire fore body and planes were crushed to atoms, the tail still remained as a relic, to show its comparative freedom from the accident.

In all monoplanes the tail really forms part of the supporting surface of the machine, and the adding of the weight of the gasoline would be placing but little additional duty on the tail, and it could be readily provided for by a larger tail surface, if required.

**THE CLOSED-IN BODY.**—The closed-in body is a vast improvement, which has had the effect of giving greater security to the pilot, but even this is useless in case of overturning.

**STARTING THE MACHINE.**—The direction in which improvements have been slow is in the starting of the machine. The power is usually so mounted that the pilot has no control over the starting, as he is not in a position to crank it.

The propeller being mounted directly on the shaft, without the intervention of a clutch, makes it necessary, while on the ground, for the propeller to be started by some one outside, while

others hold the machine until it attains the proper speed.

This could be readily remedied by using a clutch, but in the past this has been regarded as one of the weight luxuries that all have been trying to avoid. Self starters are readily provided, and this with the provision that the propeller can be thrown in or out at will, would be a vast improvement in all machines.

**PROPELLERS WITH VARYING PITCH.**—It is growing more apparent each day, that a new type of propeller must be devised which will enable the pilot to change the pitch, as the speed increases, and to give a greater pitch, when alighting, so as to make the power output conform to the conditions.

Such propellers, while they may be dangerous, and much heavier than the rigid type, will, no doubt, appear in time, and the real improvement would be in the direction of having the blades capable of automatic adjustment, dependent on the wind pressure, or the turning speed, and thus not impose this additional duty on the pilot.

## CHAPTER XI

### FLYING MACHINE ACCESSORIES

**THE ANEMOMETER.**—It requires an expert to judge the force or the speed of a wind, and even they will go astray in their calculations. It is an easy matter to make a little apparatus which will accurately indicate the speed. A device of this kind is called an *Anemometer*.

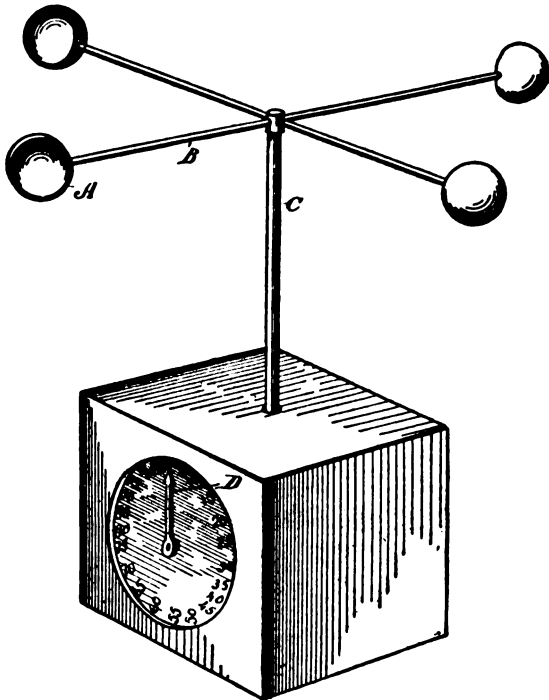
Two other instruments have grown out of this, one to indicate the *pressure*, and the other the *direction* of the moving air current.

**THE ANEMOGRAPH.**—While these instruments indicate, they are also made so they will record the speed, the pressure and the direction, and the device for recording the speed and pressure is called a *Anemograph*.

All these instruments may be attached to the same case, and thus make a handy little device, which will give all the information at a glance.

**THE ANEMOMETROGRAPH.**—This device for recording, as well as indicating the speed, pressure and direction, is called an *Anemometrograph*. The two important parts of the combined appa-

ratus, for the speed and pressure, are illustrated, to show the principle involved. While the speed will give the pressure, it is necessary to make a calculation to get the result while the machine does this for you.

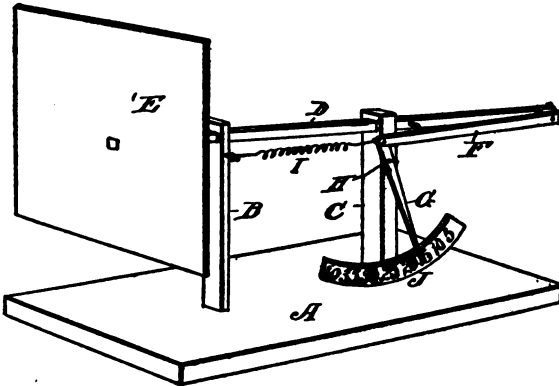


*Fig. 61. Speed Indicator.*

THE SPEED INDICATOR.—Four hemispherical cups A are mounted on four radiating arms B,

which are secured to a vertical stem C, and adapted to rotate in suitable bearings in a case, which, for convenience in explaining, is not shown.

On the lower end of the stem C, is a small bevel pinion, which meshes with a smaller bevel pinion within the base. This latter is on a shaft which carries a small gear on its other end, to mesh



*Fig. 62 Air Pressure Indicator*

with a larger gear on a shaft which carries a pointer D that thus turns at a greatly reduced speed, so that it can be easily timed.

AIR PRESSURE INDICATOR.—This little apparatus is readily made of a base A which is provided with two uprights B, C, through the upper ends of which are holes to receive a horizontally-disposed bar D. One end of the bar is a flat plane sur-



face E, which is disposed at right angles to the bar, and firmly fixed thereto.

The other end of the bar has a lateral pin to serve as a pivot for the end of a link F, its other end being hinged to the upper end of a lever G, which is pivoted to the post C, a short distance below the hinged attachment of the link F, so that the long end of the pointer which is constituted by the lever G is below its pivot, and has, therefore, a long range of movement.

A spring I between the upper end of the pointer G and the other post B, serves to hold the pointer at a zero position. A graduated scale plate J, within range of the pointer will show at a glance the pressure in pounds of the moving wind, and for this purpose it would be convenient to make the plane E exactly one foot square.

**DETERMINING THE PRESSURE FROM THE SPEED.**— These two instruments can be made to check each other and thus pretty accurately enable you to determine the proper places to mark the pressure indicator, as well as to make the wheels in the anemometer the proper size to turn the pointer in seconds when the wind is blowing at a certain speed, say ten miles per hour.

Suppose the air pressure indicator has the scale divided into quarter pound marks. This will make it accurate enough for all purposes.

CALCULATING PRESSURES FROM SPEED.—The following table will give the pressures from 5 to 100 miles per hour:

Velocity of wind in miles per hour	Pressure per sq. ft.	Velocity of wind in miles per hour	Pressure per sq.ft.
5 .....	.112	55 .....	15.125
10 .....	.500	60 .....	18.000
15 .....	1.125	65 .....	21.125
20 .....	2.000	70 .....	22.500
25 .....	3.125	75 .....	28.125
30 .....	4.500	80 .....	32.000
35 .....	6.125	85 .....	36.125
40 .....	8.000	90 .....	40.500
45 .....	10.125	95 .....	45.125
50 .....	12.5	100 .....	50.000

HOW THE FIGURES ARE DETERMINED.—The foregoing figures are determined in the following manner: As an example let us assume that the velocity of the wind is forty-five miles per hour. If this is squared, or 45 multiplied by 45, the product is 2025. In many calculations the mathematician employs what is called a *constant*, a figure that never varies, and which is used to multiply or divide certain factors.

In this case the constant is 5/1000, or, as usually written, .005. This is the same as one two hundredths of the squared figure. That would make the problem as follows:

$$45 \times 45 = 2025 \div 200 = 10.125; \text{ or,}$$

$$45 \times 45 = 2025 \times .005 = 10.125.$$

Again, twenty-five miles per hour would be  $25 \times 25 = 625$ ; and this multiplied by .005 equals 2 pounds pressure.

**CONVERTING HOURS INTO MINUTES.**—It is sometimes confusing to think of miles per hour, when you wish to express it in minutes or seconds. A simple rule, which is not absolutely accurate, but is correct within a few feet, in order to express the speed in feet per minute, is to multiply the figure indicating the miles per hour, by  $8\frac{3}{4}$ .

To illustrate: If the wind is moving at the rate of twenty miles an hour, it will travel in that time 105,600 feet ( $5280 \times 20$ ). As there are sixty minutes in an hour, 105,600 divided by 60, equals 1760 feet per minute. Instead of going through all this process of calculating the speed per minute, remember to multiply the speed in miles per hour by 90, which will give 1800 feet.

This is a little more than two per cent. above the correct figure. Again;  $40 \times 90$  equals 3600. As the correct figure is 3520, a little mental calculation will enable you to correct the figures so as to get it within a few feet.

**CHANGING SPEED HOURS TO SECONDS.**—As one-sixtieth of the speed per minute will represent the rate of movement per second, it is a comparatively

easy matter to convert the time from speed in miles per hour to fraction of a mile traveled in a second, by merely taking one-half of the speed in miles, and adding it, which will very nearly express the true number of feet.

As examples, take the following: If the wind is traveling 20 miles an hour, it is easy to take one-half of 20, which is 10, and add it to 20, making 30, as the number of feet per second. If the wind travels 50 miles per hour, add 25, making 75, as the speed per second.

The correct speed per second of a wind traveling 20 miles an hour is a little over 29 feet. At 50 miles per hour, the correct figure is  $73\frac{1}{3}$  feet, which show that the figures under this rule are within about one per cent. of being correct.

With the table before you it will be an easy matter, by observing the air pressure indicator, to determine the proper speed for the anemometer. Suppose it shows a pressure of two pounds, which will indicate a speed of twenty miles an hour. You have thus a fixed point to start from.

**PRESSURE AS THE SQUARE OF THE SPEED.**—Now it must not be assumed that if the pressure at twenty miles an hour is two pounds, that forty miles an hour it is four pounds. The pressure is as the square of the speed. This may be explained as follows: As the speed of the wind in-

creases, it has a more effective push against an object than its rate of speed indicates, and this is most simply expressed by saying that each time the speed is doubled the pressure is four times greater.

As an example of this, let us take a speed of ten miles an hour, which means a pressure of one-half pound. Double this speed, and we have 20 miles. Multiplying one-half pound by 4, the result is 2 pounds. Again, double 20, which means 40 miles, and multiplying 2 by 4, the result is 8. Doubling forty is eighty miles an hour, and again multiplying 8 by 4, we have 32 as the pounds pressure at a speed of 80 miles an hour.

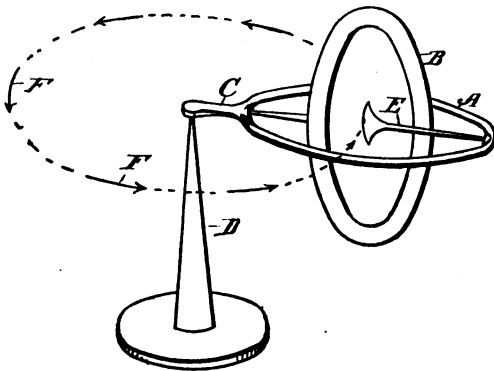
The anemometer, however, is constant in its speed. If the pointer should turn once a second at 10 miles an hour, it would turn twice at 20 miles an hour, and four times a second at 40 miles an hour.

**GYROSCOPIC BALANCE.**—Some advance has been made in the use of the gyroscope for the purpose of giving lateral stability to an aeroplane. While the best of such devices is at best a makeshift, it is well to understand the principle on which they operate, and to get an understanding how they are applied.

**THE PRINCIPLE INVOLVED.**—The only thing known about the gyroscope is, that it objects to

changing the plane of its rotation. This statement must be taken with some allowance, however, as, when left free to move, it will change in one direction.

To explain this without being too technical, examine Fig. 63, which shows a gyroscopic top, one end of the rim A, which supports the rotating wheel B, having a projecting finger C, that is



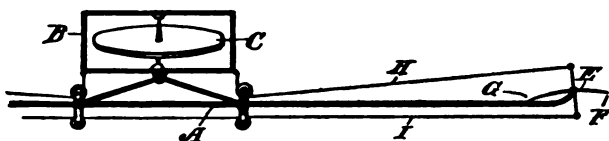
*Fig. 63. The Gyroscope.*

mounted on a pin-point on the upper end of the pedestal D.

When the wheel B is set in rotation it will maintain itself so that its axis E is horizontal, or at any other angle that the top is placed in when the wheel is spun. If it is set so the axis is horizontal the wheel B will rotate on a vertical plane, and it forcibly objects to any attempt to make it

turn except in the direction indicated by the curved arrows F.

The wheel B will cause the axis E to swing around on a horizontal plane, and this turning movement is always in a certain direction in relation to the turn of the wheel B, and it is obvious, therefore, that to make a gyroscope that will not move, or swing around an axis, the placing of two such wheels side by side, and rotated in opposite directions, will maintain them in a fixed position; this can also be accomplished by



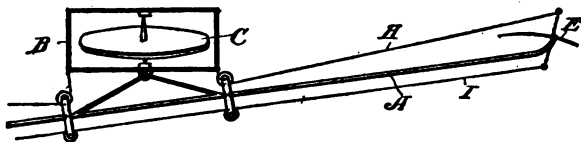
*Fig. 64. Application of the Gyroscope.*

so mounting the two that one rotates on a plane at right angles to the other.

THE APPLICATION OF THE GYROSCOPE.—Without in any manner showing the structural details of the device, in its application to a flying machine, except in so far as it may be necessary to explain its operation, we refer to Fig. 64, which assumes that A represents the frame of the aeroplane, and B a frame for holding the gyroscopic wheel C, the latter being mounted so it rotates on a horizontal plane, and the frame B being hinged

fore and aft, so that it is free to swing to the right or to the left.

For convenience in explaining the action, the planes E are placed at right angles to their regular positions, F being the forward margin of the plane, and G the rear edge. Wires H connect the ends of the frame B with the respective planes, or ailerons, E, and another wire I joins the downwardly-projecting arms of the two ailerons, so that motion is transmitted to both at



*Fig. 65. Action of the Gyroscope.*

the same time, and by a positive motion in either direction.

In the second figure, 65, the frame of the aeroplane is shown tilted at an angle, so that its right side is elevated. As the gyroscopic wheel remains level it causes the aileron on the right side to change to a negative angle, while at the same time giving a positive angle to the aileron on the left side, which would, as a result, depress the right side, and bring the frame of the machine back to a horizontal position.

FORE AND AFT GYROSCOPIC CONTROL.—It is ob-



vious that the same application of this force may be applied to control the ship fore and aft, although it is doubtful whether such a plan would have any advantages, since this should be wholly within the control of the pilot.

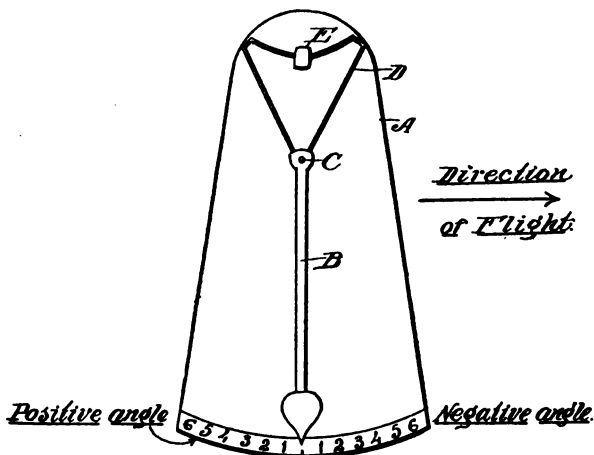
Laterally the ship should not be out of balance; fore and aft this is a necessity, and as the great trouble with all aeroplanes is to control them laterally, it may well be doubted whether it would add anything of value to the machine by having an automatic fore and aft control, which might, in emergencies, counteract the personal control of the operator.

**ANGLE INDICATOR.**—In flight it is an exceedingly difficult matter for the pilot to give an accurate idea of the angle of the planes. If the air is calm and he is moving over a certain course, and knows, from experience, what his speed is, he may be able to judge of this factor, but he cannot tell what changes take place under certain conditions during the flight.

For this purpose a simple little indicator may be provided, shown in Fig. 66, which is merely a vertical board A, with a pendulum B, swinging fore and aft from a pin C which projects out from the board a short distance above its center.

The upper end of the pendulum has a heart-shaped wire structure D, that carries a sliding

weight E. Normally, when the aeroplane is on an even keel, or is even at an angle, the weight E rests within the bottom of the loop D, but should there be a sudden downward lurch or a quick upward inclination, which would cause the pendulum below to rapidly swing in either direc-



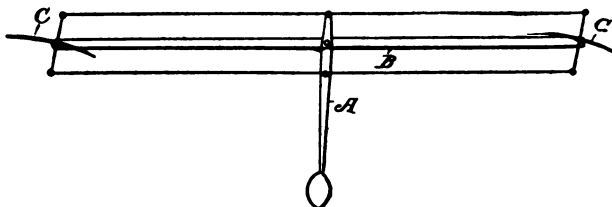
*Fig. 66. Angle Indicator.*

tion, the sliding weight E would at once move forward in the same direction that the pendulum had moved, and thus counteract, for the instant only, the swing, when it would again drop back into its central position.

With such an arrangement, the pendulum would hang vertically at all times, and the pointer below, being in range of a circle with degrees in-

licated thereon, and the base attached to the frame of the machine, can always be observed, and the conditions noted at the time the changes take place.

**PENDULUM STABILIZER.**—In many respects the use of a pendulum has advantages over the gyroscope. The latter requires power to keep it in motion. The pendulum is always in condition for service. While it may be more difficult to adjust the pendulum, so that it does not affect



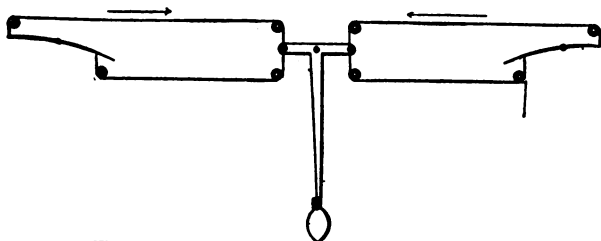
*Fig. 67 Simple Pendulum Stabilizer*

the planes by too rapid a swing, or an oscillation which is beyond the true angle desired, still, these are matters which, in time, will make the pendulum a strong factor in lateral stability.

It is an exceedingly simple matter to attach the lead wires from an aileron to the pendulum. In Fig. 67 one plan is illustrated. The pendulum A swings from the frame B of the machine, the ailerons C being in this case also shown at right angles to their true positions.

The other, Fig. 68, assumes that the machine is exactly horizontal, and as the pendulum is in a vertical position, the forward edges of both ailerons are elevated, but when the pendulum swings both ailerons will be swung with their forward margins up or down in unison, and thus the proper angles are made to right the machine.

STEERING AND CONTROLLING WHEEL.—For the purpose of concentrating the control in a single wheel, which has not alone a turning motion, but

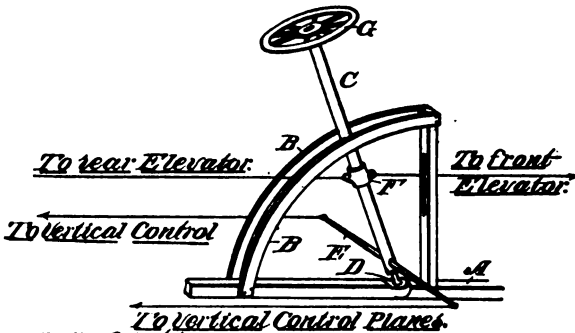


*Fig. 68. Pendulum Stabilizers.*

is also mounted in such a manner that it will oscillate to and fro, is very desirable, and is adapted for any kind of machine.

Fig. 69 shows such a structure, in which A represents the frame of the machine, and B a segment for the stem of the wheel, the segment being made of two parts, so as to form a guide-way for the stem C to travel between, and the segment is placed so that the stem will travel in a fore and aft direction.

The lower end of the stem is mounted in a socket, at D, so that while it may be turned, it will also permit this oscillating motion. Near its lower end is a cross bar E from which the wires run to the vertical control plane, and also to the ailerons, if the machine is equipped with them, or to the warping ends of the planes.



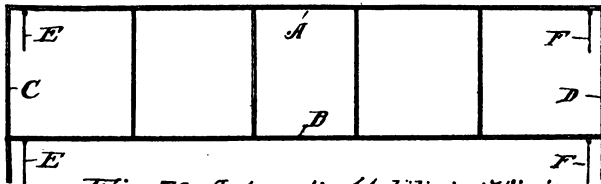
*Fig. 69. Steering and Control Wheel.*

Above the cross arms is a loose collar F to which the fore and aft cords are attached that go to the elevators, or horizontal planes. The upper end of the stem has a wheel G, which may also be equipped with the throttle and spark levers.

**AUTOMATIC STABILIZING WINGS.**—Unquestionably, the best stabilizer is one which will act on its own initiative. The difficulty with automatic devices is, that they act too late, as a general thing, to be effective. The device represented in

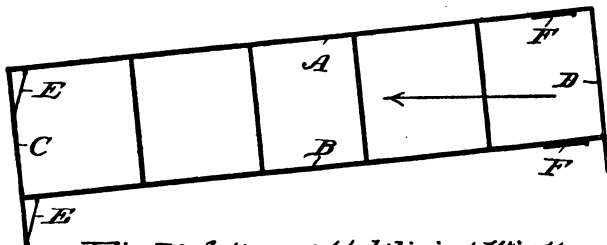
Fig. 70 is very simple, and in practice is found to be most efficient.

In this Fig. 70 A and B represent the upper and the lower planes, respectively. Near the end



*Fig. 70. Automatic Stabilizing Wings*

vertical standards C, D, are narrow wings E E, F F, hinged on a fore and aft line close below each of the planes, the wings being at such distances from the standards C D that when they swing outwardly they will touch the standards,



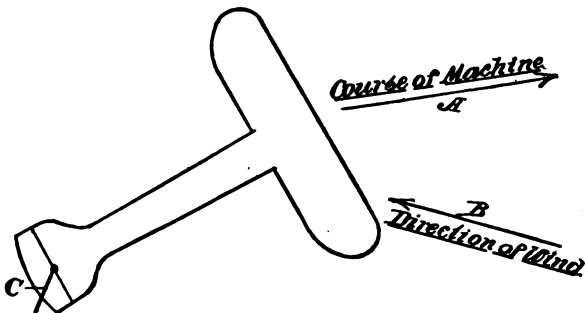
*Fig. 71. Action of Stabilizing Wings*

and when in that position will be at an angle of about 35 degrees from the planes A B.

Inwardly they are permitted to swing up and lie parallel with the planes, as shown in Fig. 71

where the planes are at an angle. In turning, all machines skid,—that is they travel obliquely across the field, and this is also true when the ship is sailing at right angles to the course of the wind.

This will be made clear by reference to Fig. 72, in which the dart A represents the direction of the movement of the aeroplane, and B the di-



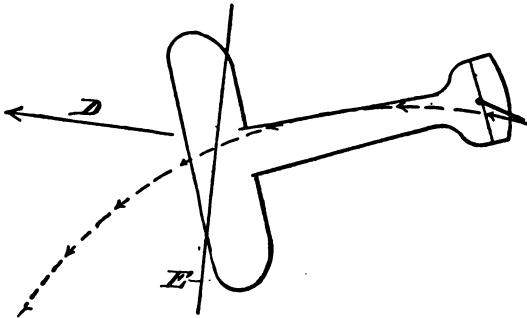
*Fig. 72. Into the Wind at an Angle.*

rection of the wind, the vertical rudder C being almost at right angles to the course of the wind.

In turning a circle the same thing takes place as shown in Fig. 73, with the tail at a different angle, so as to give a turning movement to the plane. It will be seen that in the circling movement the tendency of the aeroplane is to fly out at a tangent, shown by the line D, so that the planes of the machine are not radially-disposed

with reference to the center of the circle, the line E showing the true radial line.

Referring now to Fig. 71, it will be seen that this skidding motion of the machine swings the wings F F' inwardly, so that they offer no resistance to the oblique movement, but the wings E E, at the other end of the planes are swung outwardly, to provide an angle, which tends to raise



*Fig. 78 Turning a Circle.*

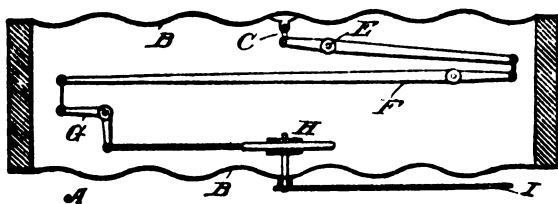
up the inner end of the planes, and thereby seek to keep the planes horizontal.

BAROMETERS.—These instruments are used for registering heights. A barometer is a device for measuring the weight or pressure of the air. The air is supposed to extend to a height of 40 miles from the surface of the sea. A column of air one inch square, and forty miles high, weighs the same as a column of mercury one inch square and 30 inches high.



Such a column of air, or of mercury, weighs  $14\frac{3}{4}$  pounds. If the air column should be weighed at the top of the mountain, that part above would weigh less than if measured at the sea level, hence, as we ascend or descend the pressure becomes less or more, dependent on the altitude.

Mercury is also used to indicate temperature, but this is brought about by the expansive quality of the mercury, and not by its weight.



*Fig. 74. Aneroid Barometer*

**ANEROID BAROMETER.**—The term *Aneroid* barometer is frequently used in connection with airship experiments. The word aneroid means not *wet*, or not a *fluid*, like mercury, so that, while aneroid barometers are being made which do use mercury, they are generally made without.

One such form is illustrated in Fig. 74, which represents a cylindrical shell A, which has at each end a head of concentrically formed corrugations. These heads are securely fixed to the ends of the shell A. Within, one of the disk heads has a

short stem C, which is attached to the short end of a lever D, this lever being pivoted at E. The outer end of this lever is hinged to the short end of another lever F, and so by compounding the levers, it will be seen that a very slight movement of the head B will cause a considerable movement in the long end of the lever F.

This end of the lever F connects with one limb of a bell-crank lever G, and its other limb has a toothed rack connection with a gear H, which turns the shaft to which the pointer I is attached.

Air is withdrawn from the interior of the shell, so that any change in the pressure, or weight of the atmosphere, is at once felt by the disk heads, and the finger turns to indicate the amount of pressure.

**HYDROPLANES.**—Hydro means water, hence the term hydroplane has been given to machines which have suitable pontoons or boats, so they may alight or initiate flight from water.

There is no particular form which has been adopted to attach to aeroplanes, the object generally being to so make them that they will sustain the greatest amount of weight with the least submergence, and also offer the least resistance while the motor is drawing the machine along the surface of the water, preparatory to launching it.

**SUSTAINING WEIGHT OF PONTOONS.**—A pontoon

having within nothing but air, is merely a measuring device which determines the difference between the weight of water and the amount placed on the pontoon. Water weighs  $62\frac{1}{2}$  pounds per cubic foot. Ordinary wood, an average of 32 pounds, and steel 500 pounds.

It is, therefore, an easy matter to determine how much of solid matter will be sustained by a pontoon of a given size, or what the dimensions of a pontoon should be to hold up an aeroplane which weighs, with the pilot, say, 1100 pounds.

As we must calculate for a sufficient excess to prevent the pontoons from being too much immersed, and also allow a sufficient difference in weight so that they will keep on the surface when the aeroplane strikes the surface in alighting, we will take the figure of 1500 pounds to make the calculations from.

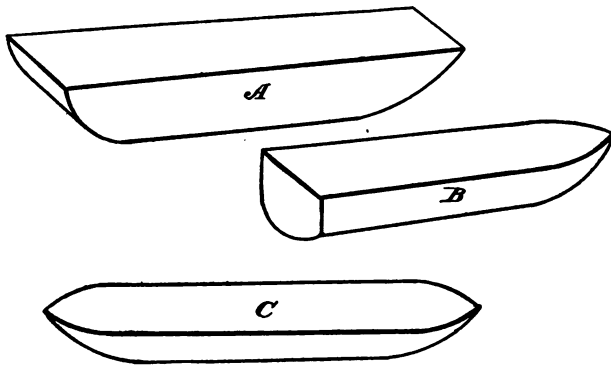
If this figure is divided by  $62\frac{1}{2}$  we shall find the cubical contents of the pontoons, not considering, of course, the weight of the material of which they are composed. This calculation shows that we must have 24 cubic feet in the pontoons.

As there should be two main pontoons, and a smaller one for the rear, each of the main ones might have ten cubic feet, and the smaller one four cubic feet.

SHAPES OF THE PONTOONS.—We are now ready

to design the shapes. Fig. 75 shows three general types, A being made rectangular in form, with a tapering forward end, so constructed as to ride up on the water.

The type B has a rounded under body, the forward end being also skiff-shaped to decrease as much as possible the resistance of the water impact.



*Fig. 75. Hydroplane Floats.*

The third type C is made in the form of a closed boat, with both ends pointed, and the bottom rounded, or provided with a keel. Or, as in some cases the body may be made triangular in cross section so that as it is submerged its sustaining weight will increase at a greater degree as it is pressed down than its vertical measurement indicates.

All this, however, is a matter left to the judgment of the designer, and is, in a great degree, dependent on the character of the craft to which it is to be applied.

## CHAPTER XII

### EXPERIMENTAL WORK IN FLYING

THE novice about to take his first trial trip in an automobile will soon learn that the great task in his mind is to properly start the machine. He is conscious of one thing, that it will be an easy matter to stop it by cutting off the fuel supply and applying the brakes.

CERTAIN CONDITIONS IN FLYING.—In an aeroplane conditions are reversed. Shutting off the fuel supply and applying the brakes only bring on the main difficulty. He must learn to stop the machine after all this is done, and this is the great test of flying. It is not the launching,—the ability to get into the air, but the landing, that gives the pupil his first shock.

Man is so accustomed to the little swirls of air all about him, that he does not appreciate what they mean to a machine which is once free to glide along in the little currents which are so unnoticeable to him as a pedestrian.


The contour of the earth, the fences, trees, little elevations and other natural surroundings, all

have their effect on a slight moving air current, and these inequalities affect the air and disturb it to a still greater extent as the wind increases. Even in a still air, with the sun shining, there are air eddies, caused by the uneven heating of the air in space.

**HEAT IN AIR.**—Heat is transmitted through the air by what is called *convection*, that is, the particles of the air transmit it from one point to the next. If a room is closed up tight, and a little aperture provided so as to let in a streak of sunlight, it will give some idea of the unrest of the atmosphere. This may be exhibited by smoke along the line of the sun's rays, which indicates that the particles of air are constantly in motion, although there may be absolutely nothing in the room to disturb it.

**MOTION WHEN IN FLIGHT.**—If you can imagine a small airship floating in that space, you can readily conceive that it will be hurled hither and thither by the motion which is thus apparent to the eye.

This motion is greatly accentuated by the surface of the earth, independently of its uneven contour. If a ball is thrown through the air, its dynamic force is measured by its impact. So with light, and heat. In the space between the planets it is very cold. The sunlight, or the rays



from the sun are there, just the same as on the earth.

Unless the rays come into contact with something, they produce no effect. When the beams from the sun come into contact with the atmosphere a dynamic force is exerted, just the same as when the ball struck an object. When the rays reach the earth, reflection takes place, and these reflected beams act on the air under different conditions.

CHANGING ATMOSPHERE.—If the air is full of moisture, as it may be at some places, while comparatively dry at other points, the reflection throughout the moist area is much greater than in the dry places, hence evaporation will take place and whenever a liquid vaporizes it means heat.

On the other hand, when the vapor is turning to a liquid, condensation takes place, and that means cooling. If the air should be of the same degree of saturation throughout,—that is, have the same amount of moisture everywhere, there would be few winds. These remarks apply to conditions which exist over low altitudes all over the earth.

But at high altitudes the conditions are entirely different. As we ascend the air becomes rarer. It has less moisture, because a wet atmosphere, being heavier, lies nearer the surface of the earth.



Being rarer the action of sunlight on the particles is less intense. Reflection and refraction of the rays acting on the light atmosphere do not produce such a powerful effect as on the air near the ground.

All these conditions—the contour of the earth; the uneven character of the moisture in the air; the inequalities of the convection currents; and the unstable, tenuous, elastic nature of the atmosphere, make the trials of the aviator a hazardous one, and it has brought out numerous theories connected with bird flight. One of these assumes that the bird, by means of its finely organized sense, is able to detect rising air currents, and it selects them in its flight, and by that means is enabled to continue in flight indefinitely, by soaring, or by flapping its wings.

**ASCENDING CURRENTS.**—It has not been explained how it happens that these particular “ascending currents” always appear directly in the line of the bird flight; or why it is that when, for instance, a flock of wild geese which always fly through space in an A-shaped formation, are able to get ascending air currents over the wide scope of space they cover.

**ASPIRATE CURRENTS.**—Some years ago, in making experiments with the outstretched wings of one of the large soaring birds, a French sailor

was surprised to experience a peculiar pulling motion, when the bird's wings were held at a certain angle, so that the air actually seemed to draw it into the teeth of the current.

It is known that if a ball is suspended by a string, and a jet of air is directed against it, in a particular way, the ball will move toward the jet, instead of being driven away from it. A well known spraying device, called the "ball nozzle," is simply a ball on the end of a nozzle, and the stream of water issuing is not effectual to drive the ball away.

From the bird incident alluded to, a new theory was propounded, namely, that birds flew because of the aspirated action of the air, and the wings and body were so made as to cause the moving air current to act on it, and draw it forwardly.

OUTSTRETCHED WINGS.—This only added to the "bird wing" theory a new argument that all flying things must have outstretched wings, in order to fly, forgetting that the ball, which has no outstretched wings, has also the same "aspirate" movement attributed to the wings of the bird.

The foregoing remarks are made in order to impress on the novice that theories do not make flying machines, and that speculations, or analogies of what we see all about us, will not make an aviator. A flying machine is a question of dy-

namics, just as surely as the action of the sun on the air, and the movements of the currents, and the knowledge of applying those forces in the flying machine makes the aviator.

**THE STARTING POINT.**—Before the uninitiated should attempt to even mount a machine he should know what it is composed of, and how it is made. His investigation should take in every part of the mechanism; he should understand about the plane surface, what the stresses are upon its surface, what is the duty of each strut, or brace or wire and be able to make the proper repairs.

**THE VITAL PART OF THE MACHINE.**—The motor, the life of the machine itself, should be like a book to him. It is not required that he should know all the theories which is necessary in the building, as to the many features which go to make up a scientifically-designed motor; but he must know how and why it works. He should understand the cam action, whereby the valves are lifted at the proper time; what the effect of the spark advance means; the throttling of the engine; air admission and supply; the regulation of the carbureter; its mechanism and construction; the propeller should be studied, and its action at various speeds.

**STUDYING THE ACTION OF THE MACHINE.**—Then comes the study on the seat of the machine itself.

It will be a novel sensation. Before him is the steering wheel, if it should be so equipped. Turning it to the right, swings the vertical tail plane so the machine will turn to the right. Certainly, he knows that; but how far must he turn the wheel to give it a certain angle.

It is not enough to know that a lever or a wheel when moved a certain way will move a plane a definite direction. He should learn to know instinctively, how *far* a movement to make to get a certain result in the plane itself, and under running conditions, as well.

Suppose we have an automobile, running at the rate of ten miles an hour, and the chauffeur turns the steering wheel ten degrees. He can do so with perfect safety; but let the machine be going forty miles an hour, and turn the wheel ten degrees, and it may mean an accident. In one case the machine is moving  $14\frac{1}{2}$  feet a second, and in the other instance 58 feet.

If the airship has a lever for controlling the angle of flight, he must study its arrangement, and note how far it must be moved to assume the proper elevating angle. Then come the means for controlling the lateral stability of the machine. All these features should be considered and studied over and over, until you have made them your friends.

While thus engaged, you are perfectly sure that you can remember and act on a set of complicated movements. You imagine that you are skimming over the ground, and your sense tells you that you have sufficient speed to effect a launching. In your mind the critical time has come.

**ELEVATING THE MACHINE.**—Simply give the elevator lever the proper angle, sharp and quick and up you go. As the machine responds, and you can feel the cushioning motion, which follows, as it begins to ride the air, you are aware of a sensation as though the machine were about to turn over to one side; you think of the lateral control at once, but in doing so forget that the elevator must be changed, or you will go too high.

You forget about the earth; you are too busy thinking about several things which seem to need your attention. Yes, there are a variety of matters which will crowd upon you, each of which require two things; the first being to get the proper lever, and the second, to move it just so far.

In the early days of aeroplaning, when accidents came thick and fast, the most usual explanation which came from the pilot, when he recovered, was: "I pushed the lever too far."

Hundreds of trial machines were built, when man learned that he could fly, and in every instance, it is safe to say, the experimenter made the

most strenuous exertion to get up in the air the first time the machine was put on the trial ground.

It is a wonder that accidents were not recorded by the hundreds, instead of by the comparatively few that were heard from. It was very discouraging, no doubt, that the machines would not fly, but that all of them, if they had sufficient power, would fly, there can be no doubt.

**HOW TO PRACTICE.**—Absolute familiarity with every part of the machine and conditions is the first thing. The machine is brought out, and the engine tested, the machine being held in leash while this is done. It is then throttled down so that the power of the engine will be less than is necessary to raise the machine from the ground.

**THE FIRST STAGE.**—Usually it will require over 25 miles an hour to raise the machine. The engine is set in motion, and now, for the first time a new sensation takes possession of you, for the reason that you are cut off from communication with those around you as absolutely as though they were a hundred miles away.

This new dependence on yourself is, in itself, one of the best teachers you could have, because it begins to instill confidence and control. As the machine darts forward, going ten or fifteen miles an hour, with the din of the engine behind you, and feeling the rumbling motion of the wheels

over the uneven surface of the earth, you have the sensation of going forty miles an hour.

The newness of the first sensation, which is always under those conditions very much augmented in the mind, wears away as the machine goes back and forth. There is only one control that requires your care, namely, to keep it on a straight course. This is easy work, but you are learning to make your control a reflex action,—to do it without exercising a distinct will power.

**PATIENCE THE MOST DIFFICULT THING.**—If you have the patience, as you should, to continue this running practice, until you absolutely eliminate the right and left control, as a matter of thought, occasionally, if the air is still turning the machine, and eventually, bringing it back, by turning it completely around, while skimming the ground, you will be ready for the second stage in the trials.

**THE SECOND STAGE.**—The engine is now arranged so that it will barely lift, when running at its best. After the engine is at full speed, and you are sure the machine is going fast enough, the elevator control is turned to point the machine in the air. It is a tense moment. You are on the alert.

The elevator is turned, and the forward end changes its relation with the ground before you.

There was a slight lift, but your caution induces you to return the planes to their normal running angle. You try it again. You are now certain that the machine made a leap and left the ground. This is the exhilarating moment.

With a calm air the machine is turned while running, by means of the vertical rudders. This is an easy matter, because while going at twenty miles an hour, the weight of the machine on the surface of the ground is less than one-tenth of its weight when at rest.

Thus the trial spins, half the time in the air, in little glides of fifty to a hundred feet, increasing in length, give practice, *practice*, PRACTICE, each turn of the field making the sport less exciting and fixing the controls more perfectly in the mind.

THE THIRD STAGE.—Thus far you have been turning on the ground. You want to turn in the air. Only the tail control was required while on the ground. Now two things are required after you leave the ground in trying to make a turn: namely, putting the tail at the proper angle, and taking charge of the stabilizers, because in making the turn in the air, the first thing which will arrest the attention will be the tendency of the machine to turn over in the direction that you are turning.



After going back and forth in straight-away glides, until you have perfect confidence and full control, comes the period when the turns should be practiced on. These should be long, and tried only on that portion of the field where you have plenty of room.

**OBSERVATIONS WHILE IN FLIGHT.**—If there are any bad spots, or trees, or dangerous places, they should be spotted out, and mentally noted before attempting to make any flight. When in the air during these trials you will have enough to occupy your mind without looking out for the hazardous regions at the same time.

Make the first turns in a still air. If you should attempt to make the first attempts with a wind blowing you will find a compound motion that will very likely give you a surprise. In making the first turn you will get the sensation of trying to fly against a wind. Assuming that you are turning to the left, it will have the sensation of a wind coming to you from the right.

**FLYING IN A WIND.**—Suppose you are flying directly in the face of a wind, the moment you begin to turn the action, or bite of the wind, will cause the ends of the planes to the right to be unduly elevated, much more so than if the air should be calm. This raising action will be liable to startle

you, because up to this time you have been accustomed to flying along in a straight line.

While flying around at the part of the circle where the wind strikes you directly on the right side the machine has a tendency to climb, and you try to depress the forward end, but as soon as you reach that part of the circle where the winds begin to strike on your back, an entirely new thing occurs.

As the machine is now traveling with the wind, its grip on the air is less, and since the planes were set to lower the machine, at the first part of the turn, the descent will be pretty rapid unless the angle is corrected.

**FIRST TRIALS IN QUIET ATMOSPHERE.**—All this would be avoided if the first trials were made in a quiet atmosphere. Furthermore, you will be told that in making a turn the machine should be pointed downwardly, as though about to make a glide. This can be done with safety, in a still air, although you may be flying low, but it would be exceedingly dangerous with a wind blowing.

**MAKING TURNS.**—When making a turn, under no circumstances try to make a landing. This should never be done except when flying straight, and then safety demands that the landing should be made against the wind and not with it. There

are two reasons for this: First, when flying with the wind the speed must be greater than when flying against it.

By greater speed is meant relative to the earth. If the machine has a speed of thirty miles an hour, in still air, the speed would be forty miles an hour going with the wind, but only twenty miles against the wind. Second, the banking of the planes against the air is more effective when going into the wind than when traveling with it, and, therefore, the speed at which you contact with the earth is lessened to such an extent that a comparatively easy landing is effected.

**THE FOURTH STAGE.**—After sufficient time has been devoted to the long turns shorter turns may be made, and these also require the same care, and will give an opportunity to use the lateral controls to a greater extent. Begin the turns, not by an abrupt throw of the turning rudder, but bring it around gently, correcting the turning movement to a straight course, if you find the machine inclined to tilt too much, until you get used to the sensation of keeling over. Constant practice at this will soon give confidence, and assure you that you have full control of the machine.

**THE FIGURE 8.**—You are now to increase the height of flying, and this involves also the ability to turn in the opposite direction, so that you may

be able to experience the sensation of using the stabilizers in the opposite direction. You will find in this practice that the senses must take in the course of the wind from two quarters now, as you attempt to describe the figure 8.

This is a test which is required in order to obtain a pilot's license. It means that you shall be able to show the ability to turn in either direction with equal facility. To keep an even flying altitude while describing this figure in a wind, is the severest test that can be exacted.

**THE VOLPLANE.**—This is the technical term for a *glide*. Many accidents have been recorded owing to the stopping of the motor, which in the past might have been avoided if the character of the glide had been understood. The only thing that now troubles the pilot when the engine "goes dead," is to select a landing place.

The proper course in such a case is to urge the machine to descend as rapidly as possible, in order to get a headway, for the time being. As there is now no propelling force the glide is depended upon to act as a substitute. The experienced pilot will not make a straight-away glide, but like the vulture, or the condor, and birds of that class, soar in a circle, and thus, by passing over and over the same surfaces of the earth, enable him to select a proper landing place.

**THE LANDING.**—The pilot who can make a good landing is generally a good flyer. It requires nicety of judgment to come down properly. One thing which will appear novel after the first altitude flights are attempted is the peculiar sensation of the apparently increased speed as the earth comes close up to the machine.

At a height of one hundred feet, flying thirty miles an hour, does not seem fast, because the surface of the earth is such a distance away that particular objects remain in view for some moments; but when within ten feet of the surface the same object is in the eye for an instant only.

This lends a sort of terror to the novice. He imagines a great many things, but forgets some things which are very important to do at this time. One is, that the front of the machine must be thrown up so as to bank the planes against the wind. The next is to shut off the power, which is to be done the moment the wheels strike the ground, or a little before.

Upon his judgment of the time of first touching the earth depends the success of safely alighting. He may bank too high, and come down on the tail with disastrous results. If there is plenty of field room it is better to come down at a less angle, or even keep the machine at an even keel, and the elevator can then depress the tail while running

over the ground, and thus bring the machine to rest.

Frequently, when about to land the machine will rock from side to side. In such a case it is far safer to go up into the air than to make the land, because, unless the utmost care is exercised, one of the wing tips will strike the earth and wreck the machine.

Another danger point is losing headway, as the earth is neared, due to flying at too flat an angle, or against a wind that happens to be blowing particularly hard at the landing place. If the motor is still going this does not make so much difference, but in a volplane it means that the descent must be so steep, at the last moment of flight, that the chassis is liable to be crushed by the impact.

FLYING ALTITUDE.—It is doubtful whether the disturbed condition of the atmosphere, due to the contour of the earth's surface, reaches higher than 500 feet. Over a level area it is certain that it is much less, but in some sections of the country, where the hill ranges extend for many miles, at altitudes of three and four hundred feet, the upper atmosphere may be affected for a thousand feet above.

Prof. Lowe, in making a flight with a balloon, from Cincinnati to North Carolina, which lasted a day and all of one night, found that during the

early morning the balloon, for some reason, began to ascend, and climbed nearly five thousand feet in a few hours, and as unaccountably began to descend several hours before he landed.

Before it began to ascend, he was on the western side of the great mountain range which extends south from Pennsylvania and terminates in Georgia. He was actually climbing the mountain in a drift of air which was moving eastwardly, and at no time was he within four thousand feet of the earth during that period, which shows that air movements are of such a character as to exert their influence vertically to great heights.

For cross country flying the safest altitude is 1000 feet, a distance which gives ample opportunity to volplane, if necessary, and it is a height which enables the pilot to make observations of the surface so as to be able to judge of its character.

But explanations and statements, and the experiences of pilots might be detailed in pages, and still it would be ineffectual to teach the art of flying. The only sure course is to do the work on an actual machine.

Many of the experiences are valuable to the learner, some are merely in the nature of cautions, and it is advisable for the beginner to learn what the experiences of others have been, although they may never be called upon to duplicate them.

All agree that at great elevations the flying conditions are entirely different from those met with near the surface of the ground, and the history of accidents show that in every case where a mishap was had at high altitude it came about through defect in the machine, and not from gusts or bad air condition.

On the other hand, the uptilting of machines, the accidents due to the so-called "Holes in the air," which have dotted the historic pages with accidents, were brought about at low altitudes.

At from two to five thousand feet the air may be moving at speeds of from twenty to forty miles an hour,—great masses of winds, like the trade stream, which are uniform over vast areas. To the aviator flying in such a field, with the earth hidden from him, there would be no wind to indicate that he was moving in any particular direction.

He would fly in that medium, in any direction, without the slightest sense that he was in a gale. It would not affect the control of the machine, because the air, though moving as a mass, would be the same as flying in still air. It is only when he sees fixed objects that he is conscious of the movement of the wind.



## CHAPTER XIII

### THE PROPELLER

By far the most difficult problem connected with aviation is the propeller. It is the one great vital element in the science and art pertaining to this subject which has not advanced in the slightest degree since the first machine was launched.

The engine has come in for a far greater share of expert experimental work, and has advanced most rapidly during the past ten years. But, strange to say, the propeller is, essentially, the same with the exception of a few small changes.

**PROPELLER CHANGES.**—The changes which have been made pertaining to the form of structure, principally, and in the use of new materials. The kind of wood most suitable has been discovered, but the lines are the same, and nothing has been done to fill the requirement which grows out of the difference in speed when a machine is in the act of launching and when it is in full flight.

**PROPELLER SHAPE.**—It cannot be possible that the present shape of the propeller will be its ultimate form. It is inconceivable that the propeller

is so inefficient that only one sixty-fifth of the power of the engine is available. The improvement in propeller efficiency is a direction which calls for experimental work on the part of inventors everywhere.

The making of a propeller, although it appears a difficult task, is not as complicated as would appear, and with the object in view of making the subject readily understood, an explanation will be given of the terms "Diameter," and "Pitch," as used in the art.

*The Diameter* has reference to the length of the propeller, from end to end. In calculating propeller pull, the diameter is that which indicates the speed of travel, and for this reason is a necessary element.

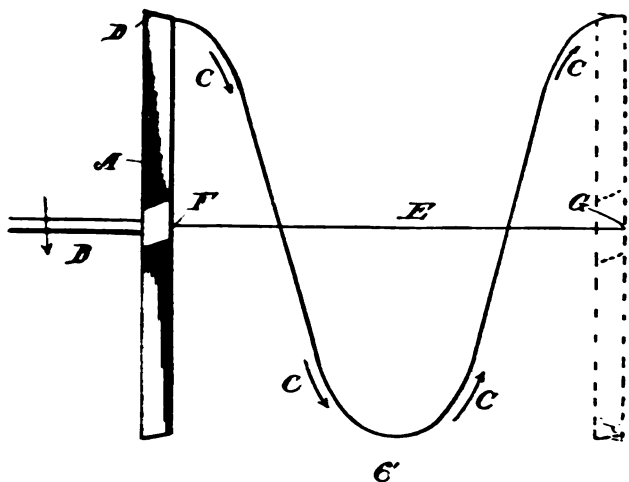
Thus, for instance, a propeller three feet in diameter, rotating 500 times a minute, has a tip speed of 1500 feet, whereas a six foot propeller, rotating at the same speed, moves 3000 feet at the tips.

**PITCH.**—This is the term which is most confusing, and is that which causes the most frequent trouble in the mind of the novice. The term will be made clear by carefully examining the accompanying illustration and the following description:

In Fig. 76 is shown a side view of a propeller

A, mounted on a shaft B, which is free to move longitudinally. Suppose we turn the shaft so the tip will move along on the line indicated by the arrow C.

Now the pitch of the blade at D is such that it will be exactly in line with the spirally-formed

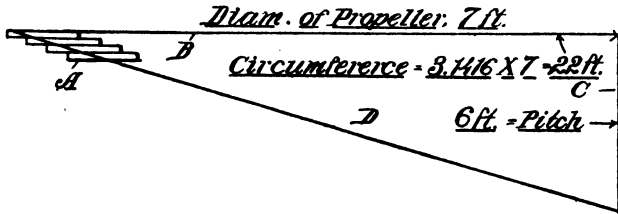


*Fig. 76. Describing the Pitch Line.*

course E, for one complete turn. As the propeller shaft has now advanced, along the line E, and stopped after one turn, at F, the measure between the points F and G represents the pitch of the propeller. Another way to express it would be to call the angle of the blade a five, or six, or a seven foot pitch, as the pitches are measured in feet.

In the illustration thus given the propeller shaft, having advanced six feet, we have what is called a six foot pitch.

Now, to lay out such a pitch is an easy matter. Assume, as in Fig. 77, that A represents the end of the blank from which the propeller is to be cut, and that the diameter of this blank, or its length from end to end is seven feet. The problem now is to cut the blades at such an angle that we shall have a six foot pitch.



*Fig. 77. Laying out the Pitch.*

LAYING OUT THE PITCH.—First, we must get the circumference of the propeller, that is, the distance the tip of the propeller will travel in making one complete turn. This is done by multiplying 7 by 3.1416. This equals 21.99, or, practically, 22 feet.

A line B is drawn, extending out horizontally along one side of the blank A, this line being made on a scale, to represent 22 feet. Secondly, at the end of this line drawn a perpendicular line

feet long. A perpendicular line is always one which is at right angles to a base line. In this case B is the base line.

Line C is made 6 feet long, because we are trying to find the angle of a 6 foot pitch. If, now, a line D is drawn from the ends of the two lines B, C, it will represent the pitch which, marked across the end of the blank A, will indicate the line to cut the blade.

**PITCH RULE.**—The rule may, therefore, be stated as follows: Multiply the diameter (in feet) of the propeller by 3.1416, and draw a line the length indicated by the product. At one end of this line draw a perpendicular line the length of the pitch requirement (in feet), and join the ends of the two lines by a diagonal line, and this line will represent the pitch angle.

Propellers may be made of wood or metal, the former being preferred for the reason that this material makes a lighter article, and is stronger, in some respects, than any metal yet suggested.

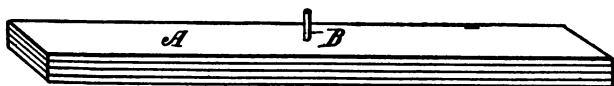
**LAMINATED CONSTRUCTION.**—All propellers should be laminated,—that is, built up of layers of wood, glued together and thoroughly dried, from which the propeller is cut.

A product thus made is much more serviceable than if made of one piece, even though the laminated parts are of the same wood, because the

different strips used will have their fibers overlapping each other, and thus greatly augment the strength of the whole.

Generally the alternate strips are of different materials, black walnut, mahogany, birch, spruce, and maple being the most largely used, but mahogany and birch seem to be mostly favored.

LAYING UP A PROPELLER FORM.—The first step necessary is to prepare thin strips, each, say, seven feet long, and five inches wide, and three-eighths of an inch thick. If seven such pieces are



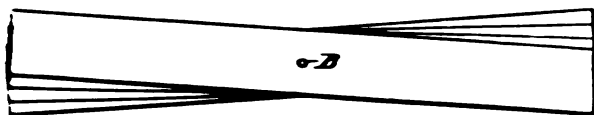
*Fig. 78. A Laminated Blank.*

put together, as in Fig. 78, it will make an assemblage of two and five-eighth inches high.

Bore a hole centrally through the assemblage, and place therein a pin B. The contact faces of these strips should be previously well painted over with hot glue liberally applied. When they are then placed in position and the pin is in place, the ends of the separate pieces are offset, one beyond the other, a half inch, as shown, for instance, in Fig. 79.

This will provide ends which are eight and a half inches broad, and thus furnish sufficient ma-

terial for the blades. The mass is then subjected to heavy pressure, and allowed to dry before the blades are pared down.



*Fig. 79. Arranging the strips.*

**MAKING WIDE BLADES.**—If a wider blade is desired, a greater number of steps may be made by adding the requisite number of strips; or, the strips may be made thicker. In many propellers, not to exceed four different strips are thus glued together. The number is optional with the maker.

An end view of such an assemblage of strips is illustrated in Fig. 80. The next step is to lay



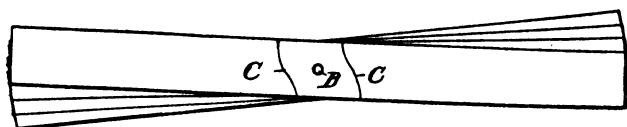
*Fig. 80. End view of Blank.*

off the pitch, the method of obtaining which has been explained.

Before starting work the sides, as well as the ends, should be marked, and care observed to

place a distinctive mark on the front side of the propeller.

Around the pin B, Fig. 81, make S-shaped marks C, to indicate where the cuts on the faces

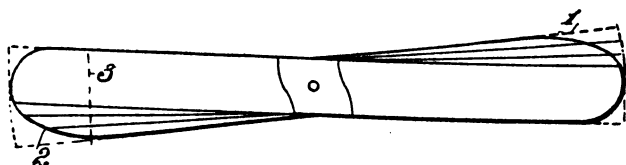


*Fig. 81. Marking the Side.*

of the blades are to begin. Then on the ends of the block scribe the pitch angle, which is indicated by the diagonal line D, Fig. 80.

This line is on the rear side of the propeller, and is perfectly straight. Along the front of this line is a bowline E, which indicates the front surface of the propeller blade.

PROPELLER OUTLINE.—While the marks thus



*Fig. 82. Outlining.*

given show the angles, and are designed to indicate the two faces of the blades, there is still another important element to be considered, and that is the final outline of the blades.



It is obvious that the outline may be varied so that the entire width at 1, Fig. 82, may be used, or it may have an outline, as represented by the line 2, in this figure, so that the widest part will be at or near the dotted line 3, say two-thirds of the distance from the center of the blade.

This is the practice with most of the manufacturers at the present time, and some of them claim that this form produces the best results.

FOR HIGH SPEEDS.—Fig. 83 shows a propeller cut from a blank, 4" x 6" in cross section, not laminated.



*Fig. 83. Cut from a 4" x 6" Single Blank.*

It should be borne in mind that for high speeds the blades must be narrow. A propeller seven feet in diameter with a six foot pitch, turning 950 revolutions per minute, will produce a pull of 350 pounds, if properly made.

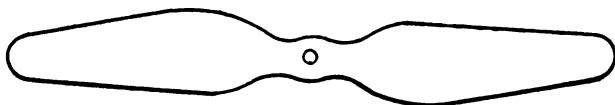
Such a propeller can be readily handled by a forty horse power motor, such as are specially constructed for flying machine purposes.

INCREASING PROPELLER EFFICIENCY.—Some experiments have been made lately, which, it is claimed, largely increase the efficiency of propel-

lers. The improvement is directed to the outline shape of the blade.

The typical propeller, such as we have illustrated, is one with the wide part of the blade at the extremity. The new type, as suggested, reverses this, and makes the wide part of the blade near the hub, so that it gradually tapers down to a narrow tip.

Such a form of construction is shown in Fig. 84. This outline has some advantages from one



*Fig. 84. A Suggested Form.*

standpoint, namely, that it utilizes that part of the blade near the hub, to produce a pull, and does not relegate all the duty to the extreme ends or tips.

To understand this more fully, let us take a propeller six feet in diameter, and measure the pull or thrust at the tips, and also at a point half way between the tip and the hub.

In such a propeller, if the blade is the same width and pitch at the two points named, the pull at the tips will be four times greater than at the intermediate point.

## CHAPTER XIV

### EXPERIMENTAL GLIDERS AND MODEL AEROPLANES

AN amusing and very instructive pastime is afforded by constructing and flying gliding machines, and operating model aeroplanes, the latter being equipped with their own power.

Abroad this work has been very successful as a means of interesting boys, and, indeed, men who have taken up the science of aviation are giving this sport serious thought and study.

When a machine of small dimensions is made the boy wonders why a large machine does not bear the same relation in weight as a small machine. This is one of the first lessons to learn.

**THE RELATION OF MODELS TO FLYING MACHINES.**  
—A model aeroplane, say two feet in length, which has, we will assume, 50 square inches of supporting surface, seems to be a very rigid structure, in proportion to its weight. It may be dropped from a considerable height without injuring it, since the weight is only between two and three ounces.

An aeroplane twenty times the length of this

model, however strongly it may be made, if dropped the same distance, would be crushed, and probably broken into fragments.

If the large machine is twenty times the dimensions of the small one, it would be forty feet in length, and, proportionally, would have only seven square feet of sustaining surface. But an operative machine of that size, to be at all rigid, would require more than twenty times the material in weight to be equal in strength.

It would weigh about 800 pounds, that is, 4800 times the weight of the model, and instead of having twenty times the plane surface would require one thousand times the spread.

It is this peculiarity between models and the actual flyers that for years made the question of flying a problem which, on the basis of pure calculation alone, seemed to offer a negative; and many scientific men declared that practical flying was an impossibility.

LESSONS FROM MODELS.—Men, and boys, too, can learn a useful lesson from the model aeroplanes in other directions, however, and the principal thing is the one of stability.

When everything is considered the form or shape of a flying model will serve to make a large flyer. The manner of balancing one will be a good criterion for the other in practice, and ex-

perimenting with these small devices is, therefore, most instructive.

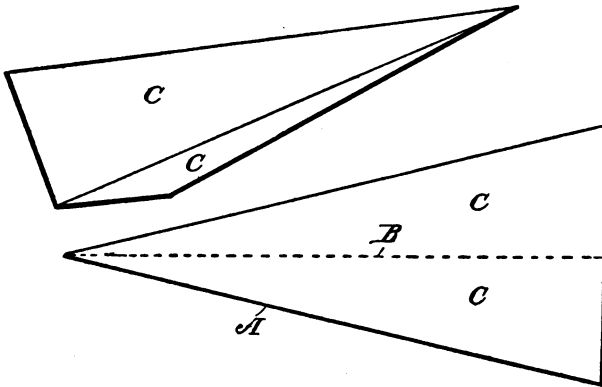
The difference between gliders and model aeroplanes is, that gliders must be made much lighter because they are designed to be projected through the air by a kick of some kind.

**FLYING MODEL AEROPLANES.**—Model aeroplanes contain their own power and propellers which, while they may run for a few seconds only, serve the purpose of indicating how the propeller will act, and in what respect the sustaining surfaces are efficient and properly arranged.

It is not our purpose to give a treatise on this subject but to confine this chapter to an exposition of a few of the gliders and model forms which are found to be most efficient for experimental work.

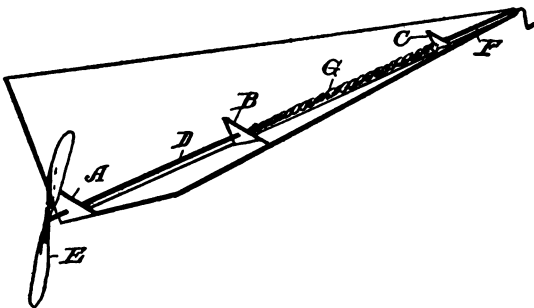
**AN EFFICIENT GLIDER.**—Probably the simplest and most efficient glider, and one which can be made in a few moments, is to make a copy of the deltoid kite, previously referred to.

This is merely a triangularly-shaped piece of paper, or stiff cardboard A, Fig. 84, creased in the middle, along the dotted line B, the side wings C, C, being bent up so as to form, what are called diedral angles. This may be shot through the air by a flick of the finger, with the pointed end foremost, when used as a glider.



*Fig. 85. Deltoid Glider*

THE DELTOID FORMATION.—This same form may be advantageously used as a model aeroplane, but in that case the broad end should be foremost.



*Fig. 86. The Deltoid Racer*

Fig. 86 shows the deltoid glider, or aeroplane, with three cross braces, A, B, C, in the two forward braces of which are journaled the propeller

shaft D, so that the propeller E is at the broad end of the glider.

A short stem F through the rear brace C, provided with a crank, has its inner end connected with the rear end of the shaft D by a rubber band G, by which the propeller is driven.

A tail may be attached to the rear end, or at the apex of the planes, so it can be set for the purpose of directing the angle of flight, but it will be found that this form has remarkable stability in flight, and will move forwardly in a straight line, always making a graceful downward movement when the power is exhausted.

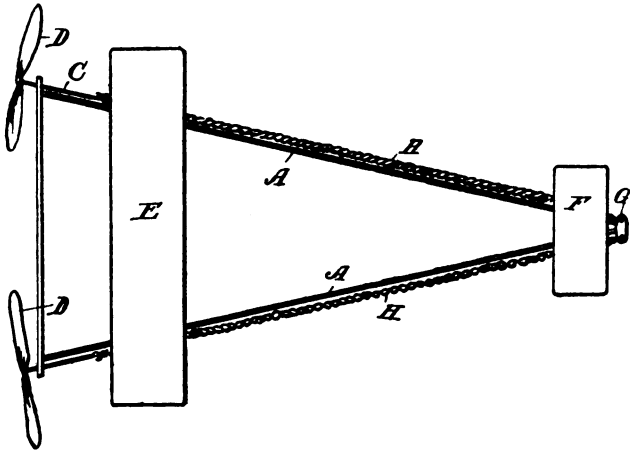
It seems to be a form which has equal stabilizing powers whether at slow or at high speeds, thus differing essentially from many forms which require a certain speed in order to get the best results.

RACING MODELS.—Here and in England many racing models have been made, generally of the A-shaped type, which will be explained hereinafter. Such models are also strong, and able to withstand the torsional strain required by the rubber which is used for exerting the power.

It is unfortunate that there is not some type of cheap motor which is light, and adapted to run for several minutes, which would be of great value in work of this kind, but in the absence of such

mechanism rubber bands are found to be most serviceable, giving better results than springs or bows, since the latter are both too heavy to be available, in proportion to the amount of power developed.

Unlike the large aeroplanes, the supporting surfaces, in the models, are at the rear end of the frames, the pointed ends being in front.



*Fig. 87. A-shaped Racing Glider:*

Fig. 87 shows the general design of the A-shaped gliding plane or aeroplane. This is composed of main frame pieces A, A, running fore and aft, joined at their rear ends by a cross bar B, the ends of which project out slightly beyond their juncture with the side bars A, A. These



projecting ends have holes drilled therein to receive the shafts C, C, of the propeller D, D.

A main plane E is mounted transversely across this frame at its rear end, while at its forward end is a small plane, called the elevator. The pointed end of the frame has on each side a turnbuckle G, for the purpose of winding up the shaft, and thus twisting the propeller, although this is usually dispensed with, and the propeller itself is turned to give sufficient twist to the rubber for this purpose.

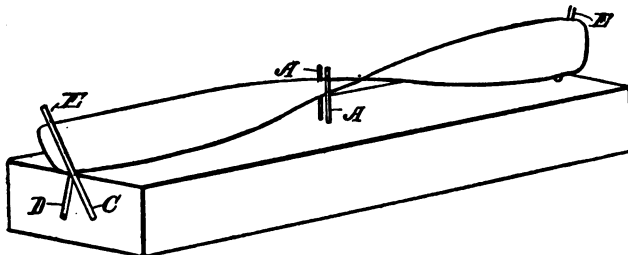
**THE POWER FOR MODEL AEROPLANES.**—One end of the rubber is attached to the hook of the shaft C, and the other end to the hook or to the turnbuckle G, if it should be so equipped.

The rubbers are twisted in opposite directions, to correspond with the twist of the propeller blades, and when the propellers are permitted to turn, their grip on the air will cause the model to shoot forwardly, until the rubbers are untwisted, when the machine will gradually glide to the ground.

**MAKING THE PROPELLER.**—These should have the pitch uniform on both ends, and a simple little device can be made to hold the twisted blade after it has been steamed and bent. Birch and holly are good woods for the blades. The strips should be made thin and then boiled, or, what is

better still, should be placed in a deep pan, and held on a grid above the water, so they will be thoroughly steamed.

They are then taken out and bent by hand, or secured between a form specially prepared for the purpose. The device shown in Fig. 88 shows a base board which has in the center a pair of parallel pins A, A, slightly separated from each other.



*Fig. 88. Making the Propellor.*

At each end of the base board is a pair of holes C, D, drilled in at an angle, the angles being the pitch desired for the ends of the propeller. In one of these holes a pin E is placed, so the pins at the opposite ends project in different directions, and the tips of the propeller are held against the ends of these pins, while the middle of the propeller is held between the parallel pins A, A.

The two holes, at the two angles at the ends of

the board, are for the purpose of making right and left hand propellers, as it is desirable to use two propellers with the A-shaped model. Two propellers with the deltoid model are not so necessary.

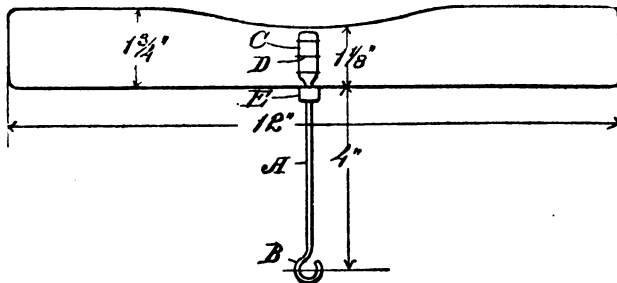
After the twist is made and the blade properly secured in position it should be allowed to thoroughly dry, and afterwards, if it is coated with shellac, will not untwist, as it is the changing character of the atmosphere which usually causes the twisted strips to change their positions. Shellac prevents the moist atmosphere from affecting them.

**MATERIAL FOR PROPELLERS.**—Very light propellers can also be made of thin, annealed aluminum sheets, and the pins in that case will serve as guides to enable you to get the desired pitch. Fiber board may also be used, but this is more difficult to handle.

Another good material is celluloid sheets, which, when cut into proper strips, is dipped in hot water, for bending purposes, and it readily retains its shape when cooled.

**RUBBER.**—Suitable rubber for the strips are readily obtainable in the market. Experiment will soon show what size and lengths are best adapted for the particular type of propellers which you succeed in making.

PROPELLER SHAPE AND SIZE.—A good proportion of propeller is shown in Fig. 89. This also shows the form and manner of connecting the shaft. The latter A has a hook B on one end to which the rubber may be attached, and its other end is flattened, as at C, and secured to the blade by two-pointed brads D, clinched on the other side.



*Fig. 89. Shape and size.*

The collar E is soldered on the shaft, and in practice the shaft is placed through the bearing hole at the end of the frame before the hook is bent.

SUPPORTING SURFACES.—The supporting surfaces may be made perfectly flat, although in this particular it would be well to observe the rules with respect to the camber of large machines.

## CHAPTER XV

### THE AEROPLANE IN THE GREAT WAR

DURING the civil war the Federal forces used captive balloons for the purpose of discovering the positions of the enemy. They were of great service at that time, although they were stationed far within the lines to prevent hostile guns from reaching them.

BALLOON OBSERVATIONS.—Necessarily, observations from balloons were and are imperfect. It was found to be very unsatisfactory during the Russian-Japanese war, because the angle of vision is very low, and, furthermore, at such distances the movements, or even the location of troops is not observable, except under the most favorable conditions.

Balloon observation during the progress of a battle is absolutely useless, because the smoke from the firing line is, necessarily, between the balloon and the enemy, so that the aerial scout has no opportunity to make any observations, even in detached portions of the fighting zone, which are of any value to the commanders.

CHANGED CONDITIONS OF WARFARE.—Since our great war, conditions pertaining to guns have been revolutionized. Now the ranges are so great that captive balloons would have to be located far in the rear, and at such a great distance from the firing line that even the best field glasses would be useless.

The science of war has also evolved another condition. Soldiers are no longer exposed during artillery attacks. Uniforms are made to imitate natural objects. The khaki suits were designed to imitate the yellow veldts of South Africa; the gray-green garments of the German forces are designed to simulate the green fields of the north.

THE EFFORT TO CONCEAL COMBATANTS.—The French have discarded the historic red trousers, and the elimination of lace, white gloves, and other telltale insignias of the officers, have been dispensed with by special orders.

In the great European war armies have burrowed in the earth along battle lines hundreds of miles in length; made covered trenches; prepared artificial groves to conceal batteries, and in many ingenious ways endeavored to make the battlefield an imitation field of nature.

SMOKELESS POWDER.—While smokeless powder has been utilized to still further hide a fighting

force, it has, in a measure, uncovered itself, as the battlefield is not now, as in olden times, overspread with masses of rolling smoke.

Nevertheless, over every battlefield there is a haze which can be penetrated only from above, hence the possibilities of utilizing the aeroplane in war became the most important study with all nations, as soon as flying became an accomplished fact.

**INVENTIONS TO ATTACK AERIAL CRAFT.**—Before any nation had the opportunity to make an actual test on the battlefield, inventors were at work to devise a means whereby an aerial foe could be met. In a measure the aerial gun has been successful, but months of war has shown that the aeroplane is one of the strongest arms of the service in actual warfare.

It was assumed prior to the European war that the chief function of the aeroplane would be the dropping of bombs,—that is for service in attacking a foe. Actual practice has not justified this theory. In some places the appearance of the aeroplane has caused terror, but it has been found the great value is its scouting advantages.

**FUNCTION OF THE AEROPLANE IN WAR.**—While bomb throwing may in the future be perfected, it is not at all an easy problem for an aviator to do work which is commensurate with the risk in-

volved. The range is generally too great; the necessity of swift movement in the machine too speedy to assure accuracy, and to attack a foe at haphazard points can never be effectual. Even the slowly-moving gas fields, like the Zeppelin, cannot deliver bombs with any degree of precision or accuracy.

**BOMB-THROWING TESTS.**—It is interesting, however, to understand how an aviator knows where or when to drop the bomb from a swiftly-moving machine. Several things must be taken into consideration, such as the height of the machine from the earth; its speed, and the parabolic curve that the bomb will take on its flight to the earth.

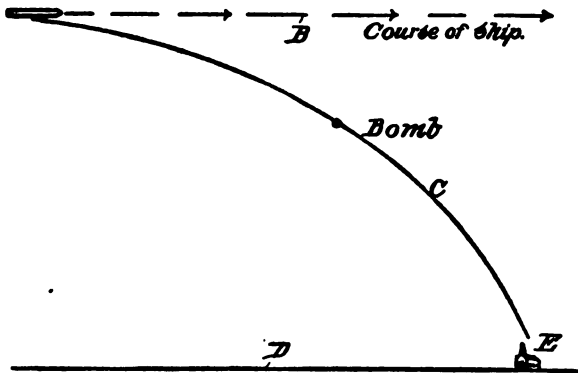
When an object is released from a moving machine it will follow the machine from which it is dropped, gradually receding from it, as it descends, so that the machine is actually beyond the place where the bomb strikes the earth, due to the retarding motion of the atmosphere against the missile.

The diagram Fig. 90 will aid the boy in grasping the situation. A is the airship; B the path of its flight; C the course of the bomb after it leaves the airship; and D the earth. The question is how to determine the proper movement when to release the bomb.

**METHOD FOR DETERMINING MOVEMENT OF A**



**BOMB.**—Lieut. Scott, U. S. A., of the Coast Survey Artillery, suggested a method for determining these questions. It was necessary to ascertain, first, the altitude and speed. While the barometer is used to determine altitudes, it is obvious that speed is a matter much more difficult to ascertain, owing to the wind movements, which in all cases make it difficult for a flier to



*Fig 90. Course of a Bomb*

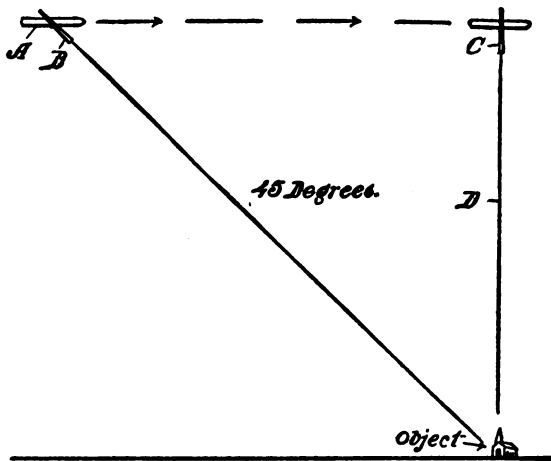
determine, even with instruments which have been devised for the purpose.

Instead, therefore, of relying on the barometer, the ship is equipped with a telescope which may be instantly set at an angle of 45 degrees, or vertically.

Thus, Fig 91 shows a ship A, on which is mounted a telescope B, at an angle of 45 degrees.

The observer first notes the object along the line of 45 degrees, and starts the time of this observation by a stop watch.

The telescope is then turned so it is vertical, as at C, and the observer watches through the telescope until the machine passes directly over



*Fig. 91. Determining Altitude and Speed.*

the object, when the watch is stopped, to indicate the time between the two observations.

The height of the machine along the line D is thus equal to the line E from B to C, and the time of the flight from B to C being thus known, as well as the height of the machine, the observer consults specially-prepared tables which show

just what kind of a curve the bomb will make at that height and speed.

All that is necessary now is to set the sighter of the telescope at the angle given in the tables, and when the object to be hit appears at the sight, the bomb is dropped.

**THE GREAT EXTENT OF MODERN BATTLE LINES.**—The great war brought into the field such stupendous masses of men that the battle lines have extended over an unbroken front of over 200 miles.

In the battle of Waterloo, about 140,000 men were engaged on both sides, and the battle front was less than six miles. There were, thus massed, along the front, over 20,000 men every mile of the way, or 10,000 on each side.

In the conflict between the Allies and the Germans it is estimated that there were less than 7500 along each mile. It was predicted in the earlier stages of the war that it would be an easy matter for either side to suddenly mass such an overwhelming force at one point as to enable the attacking party to go through the opposing force like a wedge.

Such tactics were often employed by Napoleon and other great masters of war; but in every effort where it has been attempted in the present conflict, it was foiled.

The opposing force was ready to meet the attack with equal or superior numbers. The eye of the army, the aeroplane, detected the movements in every instance.

THE AEROPLANE DETECTING THE MOVEMENTS OF ARMIES.—In the early stages of the war, when the Germans drove the left of the French army towards Paris, the world expected an investment of that city. Suddenly, and for no apparent reason, the German right was forced back and commenced to retreat.

It was not known until weeks afterwards that the French had assembled a large army to the west and northwest of Paris, ready to take the Germans in flank the moment an attempt should be made to encircle the Paris forts.

The German aviators, flying over Paris, discovered the hidden army, and it is well they did so, for it is certain if they had surrounded the outlying forts, it would have been an easy matter for the concealed forces to destroy their communications, and probably have forced the surrender of a large part of the besiegers.

The aeroplane in warfare, therefore, has constantly noted every disposition of troops, located the positions and judged the destination of convoys; the battery emplacements; and the direction in which large forces have been moved from

one part of the line to the other, thus keeping the commanders so well informed that few surprises were possible.

**THE EFFECTIVE HEIGHT FOR SCOUTING.**—It has been shown that aeroplane scouting is not effective at high altitudes. It is not difficult for aviators to reach and maintain altitudes of five thousand feet and over, but at that elevation it is impossible to distinguish anything but the movement of large forces.

**SIZES OF OBJECTS AT GREAT DISTANCES.**—At a distance of one mile an automobile, twenty feet in length, is about as large as a piece of pencil one inch long, viewed at a distance of thirty-five feet. A company of one hundred men, which in marching order, say four abreast, occupies a space of eight by one hundred feet, looks to the aviator about as large as an object one inch in length, four and a half feet from the eye.

The march of such a body of men, viewed at that distance, is so small as almost to be imperceptible to the eye of an observer at rest. How much more difficult it is to distinguish a movement if the observer is in a rapidly-moving machine.

For these reasons observations must be made at altitudes of less than a mile, and the hazard of these enterprises is, therefore, very great,

since the successful scout must bring himself within range of specially designed guns, which are effective at a range of 3000 yards or more, knowing that his only hope of safety lies in the chance that the rapidly-moving machine will avoid the rain of bullets that try to seek him out.

**SOME DARING FEATS IN WAR.**—It would be impossible to recount the many remarkable aerial fights which have taken place in the great war. Some of them seem to be unreal, so startling are the tales that have been told. We may well imagine the bravery that will nerve men to fight thousands of feet above the earth.

One of the most thrilling combats took place between a Russian aeroplane and a Zeppelin, over Russian Poland, at the time of the first German invasion. The Zeppelin was soaring over the Russian position, at an altitude of about a mile. A Russian aviator ascended and after circling about, so as to gain a position higher than the airship, darted down, and crashed into the great gas field.

The aviator knew that it meant death to him, but his devotion led him to make the sacrifice. The Zeppelin, broken in two, and robbed of its gas, slowly moved toward the earth, then gradually increased the speed of its descent, as the aeroplane clung to its shattered hulk, and by the

time it neared the earth its velocity was great enough to assure the destruction of all on board, while the ship itself was crushed to atoms.

One of the most spectacular fights of the war occurred outside Paris, when one of the German Taubes attempted to make its periodical tour of observation. One of the French aeroplanes, which had the advantage of greater speed, mounted to a greater altitude, and circled about the Taube.

The latter with its machine gun made a furious attack, during these maneuvers, but the French ship did not reply until it was at such an elevation that it could deliver the attack from above. Then its machine gun was brought into play. As was afterwards discovered, the wings and body of the Taube were completely riddled, and it was a marvel how it was possible for the German aviator to remain afloat as long as he did.

Soon the Taube was noticed to lurch from side to side, and then dart downwardly. The monoplane, in the pursuit, gradually descended, but it was not able to follow the destroyed Taube to the earth, as the latter finally turned over, and went swirling to destruction.

The observer, as well as the aviator, had both been killed by the fire from the monoplane.

In the trenches on the Marne, to the northeast

of Paris, where the most stubborn conflict raged for over a week, the air was never clear of aeroplanes. They could be seen in all directions, and almost all types of machines were represented. The principal ones, however, were monoplanes.

**THE GERMAN TAUBE.**—The German Taube is a monoplane, its main supporting surfaces, as well as the tail planes, are so constructed that they represent a bird. Taube means dove. It would have been more appropriate to call it a hawk.

On the other hand, the French monoplane, of which the Bleriot is the best known example, has wings with well rounded extremities, and flaring tail, so that the two can be readily distinguished.

On one occasion, during the lull in the battle, two of the Taubes approached the area above the French lines, and after ascending to a great height, began the volplane toward their own lines. Such a maneuver was found to be the most advantageous, as it gave the scouting aeroplane the advantage of being able to discover the positions and movements with greater ease, and at the same time, in case of accident to the machine, the impetus of the flight would be to their own lines.

Three of the French aeroplanes at once began their circling flight, mounting higher and higher, but without attempting to go near the Taubes. When the French ships had gained the proper al-



titude, they closed in toward the German ships, before the latter could reach their own lines in their volplaning act.

This meant that they must retreat or fight, and the crack of the guns showed that it meant a struggle. The monoplanes circled about with incredible skill, pouring forth shot after shot. Soon one of the Taubes was seen to flutter. This was the signal for a more concentrated attack on her.

The army in the trenches, and on the fields below, witnessed the novel combat. The flying ships were now approaching the earth, but the gunners below dared not use their guns, because in the maneuvers they would be as likely to strike friend as foe.

The wounded Taube was now shooting to the earth, and the two monoplanes began to give their attention to the other ship, which was attempting to escape to the north. The flash of the guns of all the fliers could be plainly seen, but the sounds were drowned by the roar of the great conflict all about them.

The Taube could not escape the net around her. She, too, was doomed. A shot seemed to strike the gasoline tank, and the framework was soon enveloped in flames. Then she turned sidewise, as the material on one side burned away, and skid-

ding to the left she darted to the earth, a shapeless mass.

It was found that the aviator was not hurt by the shot, but was, undoubtedly, killed by the impact with the earth. The observer was riddled with bullets, and was likely dead before the ship reached the earth.

In the western confines of Belgium, near Ypres, the British employed numerous aircraft, many of them biplanes, and at all times they were in the air, reporting observations. Many of the flying fights have been recorded, and the reports when published will be most thrilling reading.

HOW AEROPLANES REPORT OBSERVATIONS.—It may be of some interest to know how aeroplanes are able to report observations to the commanders in the field, from the airship itself. Many ingenious devices have been devised for this purpose.

SIGNAL FLAGS.—The best known and most universally used method is by the use of signaling flags. Suppose the commander of a force is desirous of getting the range of a hidden battery, or a massed force in his front. The observer in the aeroplane will sail over the area at an understood altitude, say one mile in height.

The officer in charge of the battery, knowing the height of the airship, is able, by means of

the angle thus given him, to get the distance between his battery and the concealed point beneath the airship. The observer in the airship, of course, signals the engineer officer, the exact point or time when the airship is directly above, and this gives him the correct angle.

The guns of the battery are then directed and fired so as to reach the concealed point. It is now important to be able to send intelligible signals to the officer in charge of the battery. If the shot goes beyond the mark, the observer in the airship raises the flag above his head, which indicates that it was too high.

How USED.—If the shot fell short he would lower the flag. If the shot landed too far to the right, this would be indicated by the flag, and if too far to the left, the signal would, in like manner, be sufficient to enable the gunners to correct the guns.

When the exact range is obtained the observer in the ship waves the flag about his head, in token of approval. All this work of noting the effect of the shots must be taken while the airship is under fire, and while circling about within visual range of the concealed object below.

The officer in charge of the battery, as well as the observer on the flying craft, must be equipped with powerful glasses, so the effect of the shots

may be noted on the one hand, and the signals properly read by the officer on the other hand.

It may be said, however, that air battles have not been frequent and that they have been merely incidents of the conditions under which they were operated. The mission of the aeroplane is now conceded to be purely one of observation, such as we have described.

Both French and German reports are full of incidents showing the value of observations, and also concerning the effects of bombs. Extracts from the diaries of prisoners gave many interesting features of the results of aeroplane work.

CASUALTIES DUE TO AEROPLANES.—In the diary of one was found the remark: "I was lucky to escape the bomb thrown by a French aviator at Conrobot, which killed eight of my companions."

Another says: "The Seventh Company of the Third Regiment of the Guard had eight killed and twenty-two wounded by bomb from a French aeroplane."

Another: "An officer showed us a torn coat taken from one of sixty soldiers wounded by a bomb from an aeroplane."

A prisoner says: "Near Neuville an aeroplane bomb dropped on a supply train, killed four men, wounded six, and killed a considerable number of horses."

The Belgians, after their defeat and the capture of Antwerp, were forced to the west along the coast. In some way they learned that the Kaiser was about to occupy a château near Dixmunde. Several aviators flew above the position and dropped a number of bombs on the building, completely wrecking it, and it was fortunate that the Emperor left the building only twenty minutes before, as several of his aides and soldiers on duty were killed.

On numerous occasions the headquarters of the different commanders have been discovered and had to be moved to safer places.

During all these wonderful exploits which will live in history because men had the opportunity during the war to use them for the first time in actual conflict, the official reports have not mentioned the aviators by name. The deaths of the brave men have brought forth the acknowledgments of their services. During the first three months of the war it is estimated that over sixty aviators and aides had lost their lives in the conflict on the two great battle lines. This does not take into account those who met death on the Zeppelins, of which five had been destroyed during that time.

THE END

## GLOSSARY OF WORDS

### USED IN TEXT OF THIS VOLUME

Where a word has various meanings, that definition is given which will express the terms used by the author in explaining the mechanism or subject to which it refers.

- Aviation.** The art of flying.
- Altitude.** Height; a vertical distance above any point.
- Attraction.** The art or process of drawing towards.
- Allusion.** Referring to a certain thing.
- Assume.** Taking it for granted.
- Accentuated.** To lay great stress upon a thing.
- Angle of Movement.** Any direction which is upwardly or downwardly, as distinguished from the direction of movement which is either to the right or to the left.
- Acquired.** To obtain; to recover; to procure.
- Analogous.** Corresponding to or resembling some other thing or object.
- Air Hole.** A term used to express a condition in flying where the machine while in horizontal flight takes a sudden drop, due to counter currents.
- Allerons.** Literally, small planes. Used to designate the small planes which are designed to stabilize a machine.
- Angle.** A figure, or two straight lines which start at the same point. The sides of these lines are termed the angle.
- Analysis.** To separate; to take apart and examine the various parts or elements of a thing.

- Aeroplane.** Any form of machine which has planes, and is heavier than air. Usually a flying structure which is propelled by some motive power.
- Accumulation.** Adding to; bringing together the same or unlike articles.
- Ascribable.** A reference to some antecedent source.
- Aeronautics.** The science of flying.
- Anterior.** Meaning the front or forward margin or portion of a body.
- Artifices.** Any artificial product, or workmanship.
- Axially.** Through the central portion. Thus, the shaft which goes through a cylinder is *axially* arranged.
- Automatic.** A thing which operates by its own mechanism; a contrivance which is made in such a manner that it will run without manual operation or care.
- Alertness.** Quick; being active.
- Apex.** The point at which two lines meet; also the extreme pointed end of a conical figure.
- Ascension.** Moving upwardly.
- Accessories.** The parts of a machine, or articles which may be used in connection therewith.
- Anemometer.** An instrument for measuring the force or the velocity of wind.
- Anemograph.** An instrument that usually traces a curved line on paper to make a record of the force or direction, or velocity of the wind.
- Anemometrograph.** A device which determines the force, velocity and direction of the wind.
- Accretion.** Adding to little by little.
- Accelerated.** Quickening; hurrying the process.
- Abridged.** Partly taken away from; shortened.
- Abrogate.** To dispense with; to set aside.

- Abnormal.** Not in the usual manner; not in a regular way.
- Alternate.** First one and then another; going from one side to the other.
- Ancient Lights.** An old English law which prevents a neighbor from shutting off sunlight.
- Angularly.** A line which runs out from another so that the two are not parallel.
- Aneroid.** Not wet. Applied to the type of barometer where the medium for determining the pressure is not made of mercury.
- Aspirate.** A term given by the French to that peculiar action of wing, or other body, which, when placed in certain positions, relative to a current of air, will cause it to be drawn into the current.
- Assemblage.** The bringing together of the parts or elements of a machine.
- Augment.** To aid; to add to or increase.
- Banked.** The term used in aviation which indicates that the machine is turned up so that its supporting surfaces rest against the air, as in alighting.
- Barometer.** An instrument for determining the air pressure, and thereby indicating altitudes.
- Bevel Pinion.** A toothed wheel driven by a larger wheel.
- Bi-Plane.** Two planes. In aviation that type which has two planes, similar in size, usually, and generally placed one above the other so they are separated the same distance from each other, as the width of each of the planes.
- Bulges.** A hump; an enlargement beyond the normal at any point.
- Camber, also Cambre.** The upward curve in a plane.





- Conclusion.** The end; a finding in law; a reasoning from a certain condition.
- Conductivity.** The property of materials whereby they will transmit heat along from one part to another, also electricity.
- Concentrated.** Brought together; assembled in a smaller space.
- Conclusive.** A positive ending; decisive of the matter at issue.
- Concentrically.** A line which is at all points at the same distance from one point.
- Condensation.** The act or process of making denser, or being brought together.
- Contemplate.** To consider; to judge.
- Convoys.** A protecting force which accompanies the transfer of property.
- Convection.** The diffusion of heat through a liquid or gas.
- Consistent.** A state of harmony; the same at all times.
- Constant.** In mathematics, a figure which never changes; or a figure used as a fixed valuation in a problem.
- Controllable.** Held within bounds; that which can be within the power to accomplish.
- Correctional.** The means whereby a fault may be made right.
- Consequence.** The result; that which flows from a preceding action.
- Counterforce.** An action contrary or opposite to the main force.
- Counterbalance.** Any power equally opposing another.
- Counteract.** A force acting in opposition to another.
- Counter current.** An air current which sets up in an opposite direction in the path of a moving aeroplane.
- Cushioned.** An action which takes place against a moving aeroplane, by a sudden gust of air or countercurrent.
- Dedicated.** To set apart for some special purpose.
- Degree.** An interval; a grade; a stage; a certain proportion.

- Deltoid.** Shaped like the Greek letter *delta*.
- Density.** Closeness of parts.
- Demonstration.** Making clear; showing up; an exhibition or expression.
- Deceptive.** The power or tendency to give a false impression.
- Deterrant.** To hold back; to prevent action.
- Detracting.** The tendency to take away; to belittle.
- Depressed.** To move downwardly.
- Destination.** The place set for the end of the journey.
- Despoiling.** To take away from; robbing or taking from another by force or by stealth.
- Dependant.** Hanging below; projecting from the lower side.
- Dexterity.** Agility; smartness in action.
- Deranged.** Put out of order; wrongly arranged.
- Develop.** Brought out; to put into a correct shape or form.
- Deferred.** Put over to another time.
- Designedly.** With a direct purpose.
- Diagonal.** Across an object at an angle to one or more sides.
- Diametrically.** Across an object through or near the center thereof.
- Diagram.** A mechanical plan or outline of an object.
- Dimension.** The distance across an object. The measurement, for instance, of a propeller from tip to tip.
- Dynamically.** Pertaining to motion as a result of force.
- Dispossessed.** A term used to indicate the act which removes a person from the possession of property.
- Diameter.** The measurement across an object.
- Divest.** Taken away from; removed out of.
- Disregard.** Deliberate lack of attention.
- Diversity.** The state wherein one is unlike another; dissimilarity.

- Drift.** The term used to indicate the horizontal motion, or the pull of an aeroplane.
- Dragon.** A fabulous monster, usually in the form of a serpent.
- Duplicate.** Two; made in exact imitation of an original.
- Easement.** A legal phrase to designate that right which man possesses, irrespective of any law, to gain access to his property.
- Effrontery.** Boldness with insolence; rashness without propriety.
- Effective.** To be efficient.
- Element.** One part of a whole.
- Elasticity.** Material which will go back to its original form after being distorted, is said to be *elastic*.
- Eliminate.** To take away from; to remove a part, or the whole.
- Elliptical.** Oblong with rounded ends.
- Elusive.** Capable of escaping from; hard to hold.
- Elevator.** The horizontal planes in front or rear, or in both front and rear of the supporting surfaces of an aeroplane.
- Emergency.** A sudden occurrence calling for immediate action.
- Emplacement.** A spot designed to hold heavy field pieces in intrenchments.
- Enactment.** The formulation of a law; the doing of a special thing.
- Enunciated.** Announced; setting forth of an act or a condition.
- Energy.** That quality by reason of which anything tends to move or act.
- Equidistant.** Two points or objects at equal distance from a common point.
- Equilibrium.** A balance produced by the action of two or more forces.

- Equalizing.** One made equal to the other; one side the same as the other.
- Equipped.** Armed; provided with the proper material, or in the same condition.
- Essential.** The important part or element.
- Essence.** The real character or element of the thing itself.
- External.** The outermost portion.
- Evolution.** A gradual change or building up; from a lower to a higher order.
- Evolved.** Brought out from a crude condition to a better form.
- Expression.** The art of explaining or setting forth.
- Expansion.** Growing larger; to occupy a greater space.
- Exerted.** To work to the utmost; to put forth in action.
- Exhilaration.** A lively, pleasing or happy sensation.
- Exploited.** To fully examine and consider, as well as carry out.
- Extremity.** The end; as far as can be considered.
- Facility.** Ease of management; to do things without difficulty.
- Factor.** One of the elements in a problem, or in mechanical action.
- Fascination.** Attractiveness that is pleasing.
- Flexure.** The capacity to bend and yield, and return to its original position.
- Flexible.** That which will yield; springy.
- Fore and Aft.** Lengthwise, as from stem to stern of a ship.
- Formation.** The shape or arrangement of an article or thing.
- Formulated.** Put into some concrete form, or so arranged that it may be understood.
- Frictionless.** Being without a grinding or retarding action.
- Fulcrumed.** A resting place for a lever.
- Function.** The duty or sphere of action in a person, or object.

- Glider.** An aeroplane, without power, adapted to be operated by an aviator.
- Governing.** An element which is designed to control a machine in a regular manner.
- Graduated.** A marked portion, which is regularly laid off to indicate measurements or quantities.
- Gravity.** The attraction of mass for mass. The tendency of bodies to move toward the earth.
- Gravitation.** The force with which all bodies attract each other.
- Gyratory.** Having a circular and wheeling as well as a rotary motion.
- Gyroscope.** A wheel, designed to illustrate the laws of motion, which freely revolves in gimbals within a ring, and when set into motion, objects to change its plane of rotation.
- Hemispherical.** The half of a sphere. The half of an apple would be *hemispherical*.
- Hazardous.** That which is doubtful; accompanied by danger.
- Helicopter.** A type of flying machine which has a large propeller, or more than one, revolvably fixed on vertical shafts, by means of which the machine is launched and projected through the air.
- Horizontal.** Level, like water.
- Hydroplane.** A term used to designate an aeroplane which is provided with pontoons, whereby it may alight on the water, and be launched from the surface. The term *Hydroaeroplane* is most generally used to indicate this type of machine.
- Impact.** The striking against; the striking force of one body against another.
- Immersed.** Placed under water below the surface.

- Impinge.** To strike against; usually applied where air strikes a plane or a surface at an angle.
- Imitation.** Similarity; the same in appearance.
- Incompatible.** Without harmony; incapable of existing together.
- Incurved.** Applied to a surface formation where there is a depression, or hollow.
- Inequalities.** Not smooth, or regular; uneven.
- Infinitely.** Boundless; in great number, or quality; without measure.
- Initial.** The first; that which is at the beginning.
- Indestructibility.** Not capable of being injured or destroyed.
- Influenced.** Swayed; to be induced to change.
- Inherent.** That which is in or belongs to itself.
- Initiating.** To teach; to instill; to give an insight.
- Indicator.** A term applied to mechanism which shows the results of certain operations and enables the user to read the measure, quantity, or quality shown.
- Inconceivable.** Not capable of understanding; that which cannot be understood by the human mind.
- Institute.** To start; to bring into operation.
- Insignias.** Things which are significant of any particular calling or profession.
- Instinct.** That quality in man or animals which prompts the doing of things independently of any direct knowledge or understanding.
- Intermediate.** Between; that which may be within or inside the scope of the mind, or of certain areas.
- Intervening.** The time between; also applied to the action of a person who may take part in an affair between two or more persons.
- Interval.** A time between.

- Investigator.** One who undertakes to find out certain things.
- Incidence.** In physics this is a term to indicate the line which falls upon or strikes another at an angle.
- Inverted.** Upside down.
- Invest.** To give to another thing something that it lacked before.
- Kinetic.** Consisting in or depending upon motion.
- Laminated.** Made up of a plurality of parts. When wooden strips, of different or of the same kinds are glued and then laid together and put under heavy pressure until thoroughly dried, the mass makes a far more rigid structure than if cut out of a single piece.
- Launching.** The term applied to the raising, or starting of a boat, or of a flying object.
- Lateral.** In mining this is a term to indicate the drifts or tunnels which branch out from the main tunnel. Generally it has reference to a transverse position or direction,—that is, at right angles to a fore and aft direction.
- Lift.** The vertical motion, or direction in an airship; thus the lift may be the load, or the term used to designate what the ship is capable of raising up.
- Ligament.** The exceedingly strong tendons or muscles of birds and animals, usually of firm, compact tissues.
- Limitations.** Within certain bounds; in a prescribed scope.
- Longitudinally.** Usually that direction across the longest part.
- Majestically.** Grand; exalted dignity; the quality which inspires reverence or fear.
- Manipulate.** To handle; to conduct so that it will result in a certain way.



- Maneuver.** A methodical movement or change in troops.
- Manually.** To perform by hand.
- Manifestations.** The act of making plain to the eye or to the understanding.
- Manually-operated.** With the hands; a term applied to such machines as have the control planes operated by hand.
- Maintained.** Kept up; to provide for; to sustain.
- Material.** The substance, or the matter from which an article is made; also the important thing, or element.
- Mass.** In physics it is that which in an article is always the same. It differs from weight in the particular that the *mass* of an article is the same, however far it may be from the center of the earth, whereas *weight* changes, and becomes less and less as it recedes from the center of the earth.
- Margin.** The edge; the principal difference between this word and *edge*, is, that *margin* has reference also to a border, or narrow strip along the edge, as, for instance, the blank spaces at the edges of a printed page.
- Medieval.** Belonging to the Middle Ages.
- Mercury.** A silver-white liquid metal, usually called *quicksilver*, and rather heavy. It dissolves most metals, and this process is called *amalgamation*.
- Militate.** In determining a question, to have weight, or to influence a decision.
- Mobility.** Being freely movable; capable of quick change.
- Modification.** A change; making a difference.
- Monitor.** Advising or reproving. Advising or approving by way of caution.
- Monstrosities.** Anything which is huge, or distorted, or wrong in structure.

- Monorail.** A railway with a single track, designed to be used by a bicycle form of carriage, with two wheels, fore and aft of each other, and depending for its stability upon gyroscopes, mounted on the carriage.
- Momentum.** That which makes a moving body difficult to stop. It is the weight of a moving body, multiplied by its speed.
- Monoplane.** The literal meaning is *one plane*. As monoplane machines are all provided with a fore and aft body, and each has a wing or plane projecting out from each side of this body, it is obvious that it has *two* planes instead of one. The term, however, has reference to the fact that it has only one supporting surface on the same plane. Biplanes have two supporting surfaces, one above the other.
- Multiplicity.** Frequently confounded with *plurality*. The latter means more than one, whereas *multiplicity* has reference to a great number, or to a great variety.
- Muscular.** Being strong; well developed.
- Negative.** The opposite of positive; not decisive.
- Neutrelize.** From the word *neuter*, which means *neither*, hence the term may be defined as one which is not a part of either, or does not take up with either side.
- Normal Pressure.** *Normal* means the natural or usual, and when applied to air it would have reference to the condition of the atmosphere at that particular place. If the pressure could change from its usual condition, it would be an *abnormal* pressure.
- Notoriously.** Generally known, but not favorably so; the subject of general remark; or unfavorably known.

- Obscurity.** Not well known; in the background; without clear vision; hidden from view.
- Obliquely.** That which differs from a right angle; neither obtuse nor acute; deviating from a line by any angle except a right angle.
- Obvious.** That which is readily observed and understood.
- Orthopter.** That type of flying machine which depends on flapping wings to hold it in space, and to transport it, in imitation of the motion of the wings of birds in flying.
- Oscillate.** Moving to and fro; the piston of a steam engine has an oscillating motion.
- Outlined.** Describing a marginal line on a drawing; setting forth the principal features of an argument, or the details of a story, or the like.
- Overlapping.** One placed over the other.
- Parabolic.** A form of curve somewhat similar to an ellipse.
- Pedestal.** A standard or support; an upright to hold machinery.
- Pertinent.** Appropriate; pertaining to the subject.
- Pectoral.** The bone which forms the main rib or support at the forward edge of a bird's wing.
- Persistent.** Keeping at it; determination to proceed.
- Perpendicular.** At right angles to a surface. This term is sometimes wrongly applied in referring to an object, particularly to an object which is *vertical*, meaning up and down. The blade of a square is perpendicular to the handle at all times, but the blade is vertical only when it points to the center of the earth.
- Pernicious.** Bad; not having good features or possessing wrong attributes.

- Pendulum.** A bar or body suspended at a point and adapted to swing to and fro.
- Perpetuity.** For all time; unending or unlimited time.
- Phenomena.** Some peculiar happening, or event, or object.
- Pitch.** In aviation this applies to the angle at which the blades of a propeller are cut. If a propeller is turned, and it moves forwardly in the exact path made by the angle, for one complete turn, the distance traveled by the propeller axially indicates the pitch in feet.
- Placement.** When an object is located at any particular point, so that it is operative the location is called the *placement*.
- Plane.** A flat surface for supporting a flying machine in the air. *Plane of movement* pertains to the imaginary surface described by a moving body. A bicycle wheel, for instance, when moving forwardly in a straight line, has a plane of movement which is vertical; but when the machine turns in a circle the upper end of the wheel is turned inwardly, and the plane of movement is at an angle.
- Pliant.** Easily yielding; capable of being bent; liable to be put out of shape.
- Plurality.** See *multiplicity*. More than one.
- Poise.** Held in suspension; disposed in a particular way.
- Pontoon.** Applied to a series of boats ranged side by side to support a walk laid thereon. In aviation it has reference to a float for supporting an aeroplane.
- Ponderous.** Large; heavy; difficult to handle.
- Posterior.** The rear end; the opposite of *anterior*.
- Principles.** The very nature or essence of a thing; the source or cause from which a thing springs.

- Proportion.** The relation that exists between different parts or things.
- Propounded.** Questioned; stated; to state formally for consideration.
- Proprietary.** A right; the ownership of certain property.
- Primitive.** The beginning or early times; long ago.
- Prelude.** A statement or action which precedes the main feature to be presented.
- Proximity.** Close to; near at hand.
- Prototype.** That which is used as the sample from which something is made or judged.
- Propeller.** The piece of mechanism, with screw-shaped blade, designed to be rapidly rotated in order to drive a vessel forwardly. It is claimed by some that the word *Impeller* would be the more proper term.
- Primarily.** At the first; the commencement.
- Precedes.** Goes ahead; forward of all.
- Propulsive.** The force which gives motion to an object.
- Projected.** Thrown forward; caused to fly through the air.
- Radially.** Out from the center; projecting like the spokes of a wheel.
- Ratio.** The relation of degree, number, amount; one with another.
- Reaction.** A counterforce; acting against.
- Recognise.** To know; seeing, hearing, or feeling, and having knowledge therefrom.
- Reflection.** Considering; judging one thing by the examination of another. A beam of light, or an object, leaving a surface.
- Refraction.** That peculiarity in a beam of light, which, in passing through water at an angle, bends out of its

course and again assumes a direct line after passing through.

- Reflex.** Turned back on itself, or in the direction from which it came.
- Requisite.** Enough; sufficient for all purposes.
- Relegate.** To put back or away.
- Rectangular.** Having one or more right angles.
- Reservations.** Land which is held by the Government for various purposes.
- Resistance.** That which holds back; preventing movement.
- Retarding.** Preventing a free movement.
- Revoluble.** The turning or swinging motion of a body like the earth in its movement around the sun. See *Rotative*. To cause to move as in an orbit or circle.
- Resilient.** Springy; having the quality of elasticity.
- Reversed.** Changed about; turned front side to the rear.
- Rotative.** That which turns, like a shaft. The movement of the earth on its axis is *rotative*.
- Saturation.** Putting one substance into another until it will hold no more. For instance, adding salt to water until the water cannot take up any more.
- Security.** Safety, assuredness that there will be no danger.
- Segment.** A part cut off from a circle. Distinguished from a *Sector*, which might be likened to the form of one of the sections of an orange.
- Sexagonal.** Six-sided.
- Sine of the Angle.** The line dropped from the highest point of an angle to the line which runs out horizontally.
- Sinuous.** Wavelike; moving up and down like the waves of the ocean.
- Simulates.** To pattern or copy after; the making of the like.
- Skipper.** A thin flat stone.



- Spirally-formed.** Made like an auger; twisted.
- Stability.** In airships that quality which holds the ship on an even and unswerving course, and prevents plunging and side motions.
- Structural.** Belonging to the features of construction.
- Strata.** Two or more layers; one over or below the other.
- Stream Line.** In expressing the action of moving air, or an aero-plane transported through air, every part is acted upon by the air. *Stream lines* are imaginary lines which act upon the planes at all points, and all in the same direction, or angle.
- Stupendous.** Great; important; above the ordinary.
- Substitute.** One taken for another; replacing one thing by something else.
- Supporting.** Giving aid; helping another.
- Synchronous.** Acting at the same time, and to the same extent. Thus if two wheels, separated from each other at great distances, are so arranged that they turn at exactly the same speed, they are said to turn *synchronously*.
- Tactics.** The art of handling troops in the presence of an enemy. It differs from *strategy* in the particular that the latter word is used to explain the movements or arrangement of forces before they arrive at the battle line.
- Tandem.** One before the other; one after the other.
- Tangent.** A line drawn from a circle at an angle, instead of radially.
- Technically.** Pertaining to some particular trade, science or art.
- Tenuous.** Thin, slender, willowy, slight.
- Tetrahedral.** This has reference to a form which is made up of a

multiplicity of triangularly shaped thin blades, so as to form numerous cells, and thus make a large number of supporting surfaces. Used as a kite.

- Theories.** Views based upon certain consideration.
- Theoretical.** Where opinions are founded on certain information, and expressed, not from the standpoint of actual knowledge, but upon conclusions derived from such examinations.
- Torsion.** A twist; a circular motion around a body.
- Transmitted.** Sent out; conveyed from one point to another.
- Transformation.** Changed; entirely made over from one thing to another.
- Transverse.** When a body is shorter from front to rear than from side to side its longest dimension is *transversely*. Distinguish from *lateral*, which has reference only to the distance at right angles from the main body.
- Translation.** The transportation of a body through the air.
- Trajectory.** The path made by a body projected through the air.
- Triangular.** A form or body having three sides and three angles.
- Typical.** In the form of; a likeness to.
- Ultimate.** The end; the finality; the last that can be said.
- Uninitiated.** Not having full knowledge; without information.
- Unique.** Peculiar; something that on account of its peculiar construction or arrangements stands out beyond the others.
- Universal.** Everywhere; all over the world.
- Undulate.** To move up and down; a wave-like motion.
- Utility.** Of use; to take advantageous use of.
- Unstable.** Not having anything permanent; in a ship in flight one that will not ride on an even keel, and is liable to pitch about.



- Vacuum.** Where air is partly taken away, or rendered rarer.
- Valved.** A surface which has a multiplicity of openings with valves therein, or, through which air can move in one direction.
- Vaunted.** To boast concerning; to give a high opinion.
- Velocity.** Speed; the rate at which an object can move from place to place.
- Vertically.** A line running directly to the center of the earth; a line at right angles to the surface of water.
- Vibratory.** Moving from side to side; a regular motion.
- Volplane.** The glide of a machine without the use of power.
- Warping.** The twist given to certain portions of planes, so as to cause the air to act against the warped portions.
- Weight.** The measure of the force which gravity exerts on all objects.

